

## V4730C/V8730C/V4734C 1:1 Gas/Air Servo Regulated Valves

### OPERATING INSTRUCTIONS

· Edition 05.23 · 32-00284-01 · EN

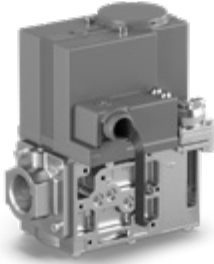

### CONTENTS

1 Safety	1
2 Checking the usage	2
3 Installation	2
4 Wiring	3
5 Tightness test	4
6 Commissioning	7
7 Adjust servo regulator	7
8 Maintenance	8
9 Troubleshooting	9
10 Accessories	9
11 Technical data	10
12 Certification	12
13 Logistics	12
14 Disposal	12

### 1 SAFETY

#### 1.1 Please read and keep in a safe place



Please read through these instructions carefully before installing or operating. Following the installation, pass the instructions on to the operator. This unit must be installed and commissioned in accordance with the regulations and standards in force. These instructions can also be found at [www.docuthek.com](http://www.docuthek.com).

#### 1.2 Explanation of symbols

**1, 2, 3, a, b, c** = Action

→ = Instruction

#### 1.3 Liability

We will not be held liable for damage resulting from non-observance of the instructions and non-compliant use.

#### 1.4 Safety instructions

Information that is relevant for safety is indicated in the instructions as follows:

#### **DANGER**

Indicates potentially fatal situations.

#### **WARNING**

Indicates possible danger to life and limb.

#### **CAUTION**

Indicates possible material damage.

All interventions may only be carried out by qualified gas technicians. Electrical interventions may only be carried out by qualified electricians.

#### 1.5 Conversion, spare parts

All technical changes are prohibited. Only use OEM spare parts.

## 2 CHECKING THE USAGE

The 1:1 Gas/Air Servo Regulated Valves, with an additional venturi mixing unit (VMU) and a fan, are used for modulating premixing units, such as gas burners, gas boilers, roof units, fresh air units and process applications.

This function is only guaranteed when used within the specified limits – see page 10 (11 Technical data). Any other use is considered as non-compliant. See instruction sheet VMU "VMU Series Venturi Mixing Unit for V473xC/V873xC Combination Gas Controls" [www.docuthek.com](http://www.docuthek.com).

Check the ratings given in the instructions and on the product to make sure the product is suitable for your application.

### 2.1 Type code

<b>V</b>	Safety shut-off valve
<b>4</b>	Line voltage
<b>73</b>	Combination control
<b>0</b>	Small body size models
<b>4</b>	Large body size models
<b>C</b>	Integrated gas/air 1:1
<b>xxxx</b>	Specification number

### 2.2 Part designations

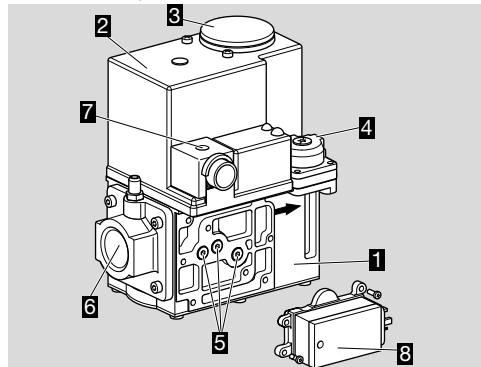

- 1 Main body
- 2 Cover
- 3 Cap
- 4 Servo regulator gas/air 1:1
- 5 Pressure tap points
- 6 Inlet flange
- 7 Electrical connection  
(connector type: ISO 4400/DIN 43650 Form A)
- 8 Pressure switches (Option)

## 3 INSTALLATION

### ⚠ CAUTION

Incorrect installation

Please observe the following to ensure that the unit is not damaged during installation and operation:

- Sealing material and dirt, e.g. thread cuttings, must not be allowed to get into the valve housing.
- Dropping the device can cause permanent damage. In this event, replace the entire device and associated modules before use.
- Turn off gas supply before installation.
- Disconnect power supply to the valve actuator before beginning the installation to prevent electrical shock and damage to the equipment.
- Do not remove the seal over valve inlet and outlet, until ready to connect piping.
- The valve must be installed so that the arrow on the valve points in the direction of the gas flow (gas pressure helps to close the valve).
- Screws which are protected against unauthorised removal must not be loosened. This will invalidate the warranty!

### 3.1 Installation position

Solenoid actuator in the vertical upright position or tilted up to the horizontal, not upside down.

Gas valves with integrated gas/air 1:1: The factory settings are made in a horizontal installation position. A vertical installation may require readjustments.

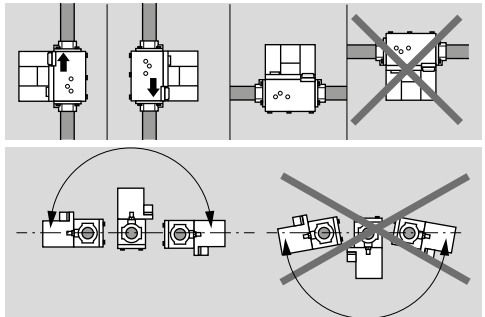

The distance between the gas valve and the wall/ground, must be at least 30 cm.

→ The valve can be mounted up to  $\pm 90$  degrees from this position without affecting the fuel/air metering at medium and high firing rates (3000 to 5000 rpm of the blower), but at lower firing rates (1000 rpm) the fuel might be reduced up to 10% when the valve is not mounted horizontal. To counter this, the low fire gas flow may be carefully field adjusted for non-horizontal mounting as described below.

### 3.2 Install valve

- 1 Take care that dirt does not enter the gas valve during handling.
- 2 Remove flanges from the valve (if factory mounted).

- 3 Use new, properly reamed, pipe, free from chips.
- 4 Apply a moderate amount of good quality pipe dope, resistant to the action of liquefied petroleum (LP) gas, only on the pipe threads.
- 5 Screw the flanges onto the pipes.
- 6 Ensure that the inlet and outlet flanges are in line and separate from each other enough to allow the valve to be mounted between the flanges without damaging the "O"-ring.
- 7 Make sure O-ring sealing surfaces are clean.
- 8 Using general purpose lithium grease, grease the O-ring.
- 9 Install the O-ring into the O-ring groove provided on the valve body (one O-ring per groove).
- 10 Mount the gas valve between the flanges using the bolts for each flange.
- 11 Complete the electrical connections as instructed in the Electrical Connection section.
- 12 Complete the electrical connections as instructed in the wiring section.

### 3.3 Connections

There are 1/8 inch (3 mm) NPT pressure taps at the flanges. At the main body flange connections are provided to mount either an:

- pressure switches (min. or max.)
- valve proving system (VPS)

#### 3.3.1 Pressure tap points

The following pressures can be measured:

- 1 Inlet pressure
- 2 Inlet pressure
- 3 Interim pressure - unregulated (pressure between the two shut-off valves)
- 4 Outlet pressure - regulated
- P Pilot gas pressure

- The corresponding numbers can be found on the sides of the valve. Pressure points 1 and 4 are located on top of the flanges.
- A pressure switch can be mounted to 2, P or 3. (C60VR: Only 2 and 3)

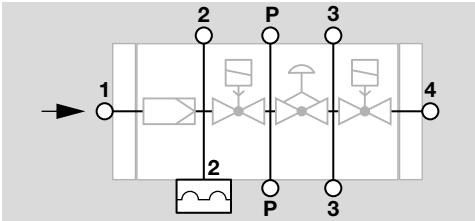

Pressure tap points for small body size models.

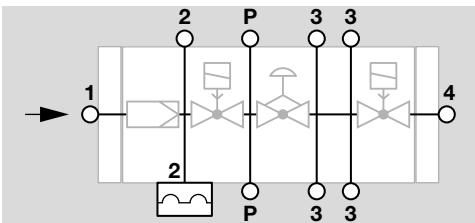

Pressure tap points for large body size model

### 3.3.2 Legend

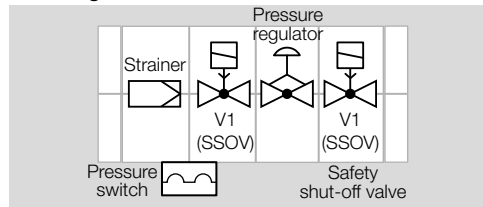

## 4 WIRING

### ⚠ WARNING

Risk of injury!

Please observe the following to ensure that no damage occurs:

- Electric shocks can be fatal! Before working on possible live components, ensure the unit is disconnected from the power supply.
- Switch off power supply before making electrical connections.
- All wiring must comply with local codes, ordinances and regulations.
- Use lead wire which can withstand 105°C ambient.

→ Use 14, 16 or 18 AWG copper conductor, 600 volt insulation, moisture-resistant wire for line voltage connections.

→ Recommended wire types are TTW60C, THW75C or THHN90C.

- T1 (yellow) will be L2 (120 or 24 V AC).
- T2 (black) will be L1 (120 or 24 V AC) to Valve 1.
- T3 (blue) will be L1 (120 or 24 V AC) to Valve 2.
- Ground (green) will be earth ground.

1 Disconnect the system from the electrical power supply.

2 Shut off the gas supply.

→ Before wiring, the fitter should ground himself.

3 Wire as shown on the connection diagram.

→ Three pin electrical plug connector according to ISO 4400/DIN 43650 (Form A).

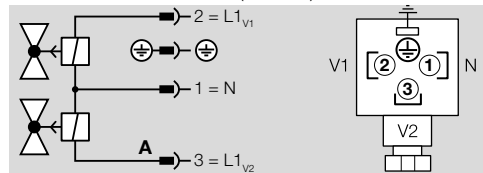

4 After successful wiring, continue with page 4 (5 Tightness test) and page 7 (6.1 Adjust valve).

## 5 TIGHTNESS TEST

### 5.1 Checking for tightness

This is a test for checking the closure tightness of the gas shutoff valve.

It should be performed only by trained, experienced, flame safeguard technicians during the initial startup of the burner system or whenever the valve is replaced.

It is recommended that this test should also be included in the scheduled inspection and maintenance procedures.

For a periodic inspection test, also follow steps below.

### ⚠ WARNING

Electrical Shock Hazard. Can cause severe injury or death.

Please observe the following:

- Remove the power from the system before beginning the valve leak test to prevent electrical shock. More than one disconnect may be involved.

1 De-energize the control system to make sure no power goes to the valves.

2 Close the upstream manual gas cock **A**.

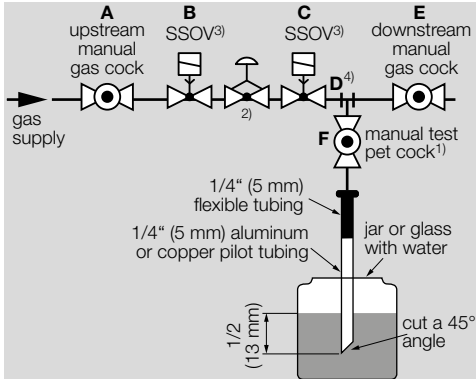

Valve leak test

1) Can also be a permanent petcock

2) Pressure regulator

3) Safety shut-off valve

4) Use the downstream tap on the SSOV

3 Make sure the manual test petcock **F** is closed in the leak test tap assembly.

4 To test the first SSOV (safety shut-off valve), remove the 1/8" (3 mm) NPT plug from pressure tap point **P**.

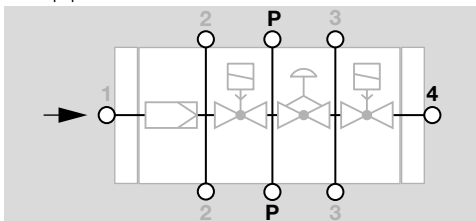

5 Install the leak test tap into pressure tap point **P** on the valve body.

6 Open the upstream manual gas cock **A** to re-pressurize the first SSOV **B**.

7 Immerse the 1/4" (6 mm) tube vertically 1/2" (13 mm) in a jar of water.

8 Slowly open the manual test petcock **F**.

9 When the rate of bubbles coming through the water stabilizes, count the number of bubbles appearing during a 10-second period.

→ Each bubble appearing represents a flow rate of 0.001 cfh (28 cm<sup>3</sup>/h). See table "Max. bubbles per pipe size".

10 Close the upstream manual gas cock **A**.

11 Remove the leak test tap from the valve body.

12 Using a small amount of pipe sealant on the 1/8" (3 mm) NPT plug, reinstall the plug in pressure tap point **P**.

13 To test the second SSOV, remove the 1/8 in. (3 mm) NPT plug from the flange pressure tap point **4**.

14 Install the leak test tap into pressure tap point **4**.

15 Close the downstream manual gas cock **E**.

16 Energize the first SSOV **B**.

### Max. bubbles per pipe size

Pipe size (in NPT)	Maximum seat leakage (UL) in cch	Maximum number of bubbles in 10 second
1/2–3/4	235	6
1	275	7
1–1/4	240	8

17 Immerse the 1/4" (6 mm) tube vertically 1/2" (13 mm) into a jar of water.

18 Slowly open the manual test petcock **F**.

19 When the rate of bubbles coming through the water stabilizes, count the number of bubbles appearing during a 10-second period. Each bubble appearing during a 10-second period represents a flow rate of 0.001 cfh (28 cm<sup>3</sup>/h). See table "Max. bubbles per pipe size".

20 De-energize first SSOV.

21 Remove the leak test tap from the valve body.

22 Using a small amount of pipe sealant on the 1/8" (3 mm) NPT plug, reinstall the plug in pressure tap point **4**.

### After the Test

23 Make sure the downstream manual gas cock **E** is closed.

24 Open the upstream manual gas cock **A** and energize the valve through the safety system.

25 Test with rich soap and water solution to make sure there is no leak at the test tap **D** or any pipe adapter/valve mating surfaces.

26 De-energize the valve **C**.

27 Open the downstream manual gas cock **E**.

28 Restore the system to normal operation.

## 5.2 Tightness for applications without without manual shut-off valve

According North American standards and European EN161 standards.

This is a test for checking the closure tightness of the gas safety shutoff valves. It should be performed only by trained experienced flame safeguard control technicians during the initial startup of the burner system.

It is recommended that this test also be included in the initial commissioning or scheduled inspection and maintenance procedures.

**1** De-energize the control system to make sure no power goes to the valves.

→ The de-energized gas valves are closed.

**2** Measure inlet pressure continuously during the test.

**3** Close the upstream manual shutoff gas cock.

**4** Remove a 1/8" NPT plug from one of the pressure tap point **3**

→ If a tap **3** is not readily available, use one of the **P** taps as an alternative.

**5** Install an accurate pressure gauge or manometer with 1/4" flexible connection tubing (max. internal diameter 3/16 inch, maximum length 2 feet) suitable for the max. inlet pressure.

**6** Open the upstream manual shutoff gas cock.

### To test V1

**7** Energize V2 to purge out the system, wait for indicated pressure to stabilize at zero.

**8** De-energize V2 and simultaneously start a timer to monitor for pressure buildup in between V1 and V2.

**9** Stop the timer when...

– North American standards: Stop the timer when pressure reaches 50% of the measured inlet pressure. For example, if the pressure to the valve inlet is 14" WC. at start of the testing, stop the timer when the pressure at the manometer reaches 7" WC.

– European EN 161 standard: Stop the timer when pressure reaches 20% of the measured inlet pressure. For example, if the pressure to the valve inlet is 14" WC. at start of the testing, stop the timer when the pressure at the manometer reaches 2.8" WC.

**10** The recorded time should be longer than the indicated "minimum time", refer to page 6 (5.2.1 Time chart allowable valve seat leakage rate), for the measured inlet pressure and fuel.

**11** Alternatively, for shortest test time, the test may be stopped at the time specified in page 6 (5.2.1 Time chart allowable valve seat leakage rate). Leakage is within acceptable limits if the pressure at that time is still less than 50% (North American standards) / 20% (European EN161 standard) of the measured inlet pressure.

### To test V2

**12** Energize V1 to pressurize the system, wait for indicated pressure to stabilize at the inlet pressure.

**13** De-energize V1 and simultaneously start a timer to monitor for pressure buildup in between V1 and V2.

**14** Stop the timer when...

– North American standards: Stop the timer when pressure reaches 50% of the measured inlet pressure. For example, if the pressure to the valve inlet is 14" WC. at start of the testing, stop the timer when the pressure at the manometer reaches 7" WC.

– European EN161 standard: Stop the timer when pressure reaches 80% of the measured inlet pressure. For example, if the pressure to the valve inlet is 14" WC. at start of the testing, stop the timer when the pressure at the manometer reaches 11.2" WC.

**15** The recorded time should be longer than the indicated "minimum time", refer to page 6 (5.2.1 Time chart allowable valve seat leakage rate).

**16** Alternatively, for shortest test time, the test may be stopped at the time specified in page 6 (5.2.1 Time chart allowable valve seat leakage rate). Leakage is within acceptable limits if the pressure at that time is still less than 50% (North American standards) / 80% (European EN161 standard) of the measured inlet pressure.

**17** Valves are tight: Remove the test pressure gauge or manometer from the valve. Remove power to the system.

**18** Using a small amount of pipe sealant on the 1/8" NPT plug, reinstall the plug in the pressure tap.

### After the Test

**19** Test with rich soap and water solution to make sure there is no leak at the test tap and any other piping connections.

**20** Restore the system to normal operation.

## 5.2.1 Time chart allowable valve seat leakage rate

This timing chart was developed to meet **ANSI Z21.21/CSA 6.5** requirements

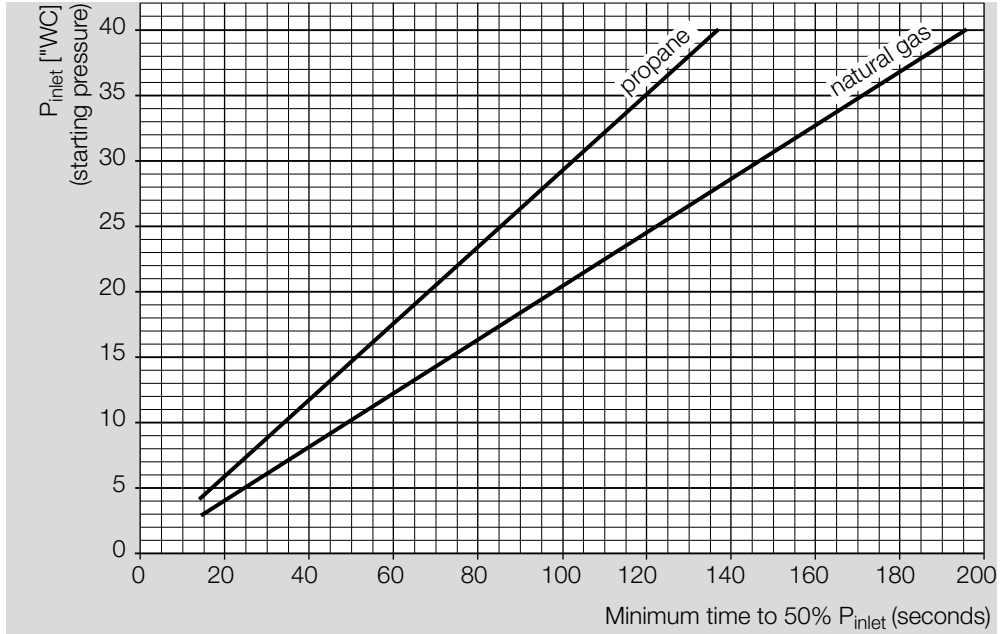

ANSI Z21.21/CSA 6.5

This timing chart was developed to meet **EN 161** requirements.

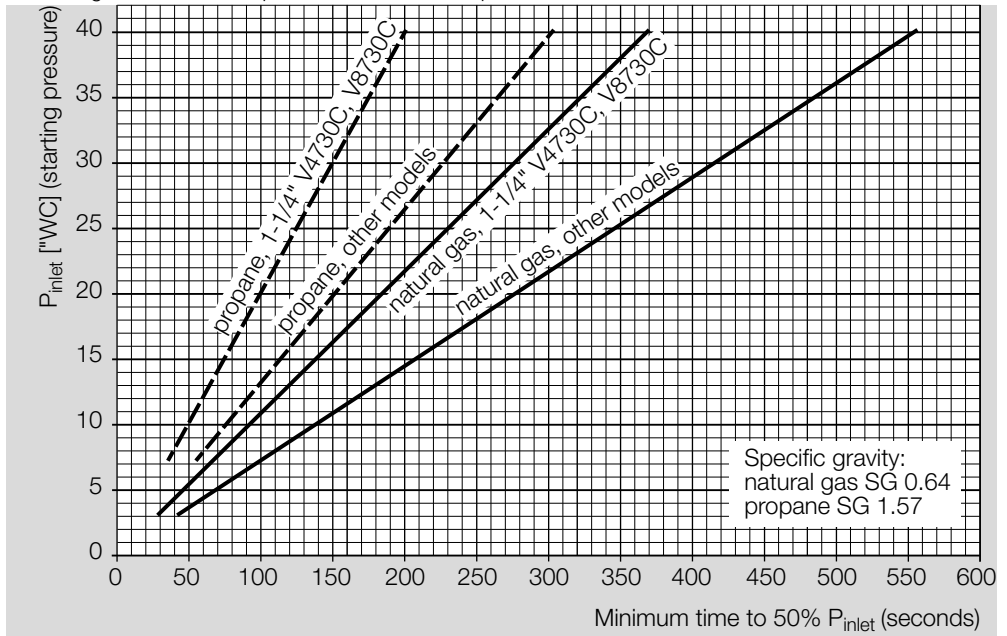

EN 161

## 6 COMMISSIONING

The V4730C/V8730C/V4734C are normally closed valves. The valves open when energized and close when power is removed.

### **⚠ WARNING**

Explosion and Electrical Shock Hazard. Can cause severe injury, death or property damage.

Please observe the following:

- Do not put the system into service until you have satisfactorily completed the Valve Leak Test, all applicable tests described in the instructions for the flame safe-guard control, and any other tests required by the burner manufacturer.
- All tests must be performed by a trained, experienced, flame safeguard technician.
- Close all manual fuel shutoff valves immediately if trouble occurs.
- After the installation is complete, cycle the valve several times with the manual fuel shutoff valve cock closed. Make sure the valve functions properly.
- Also, perform the Valve Leak Test before putting the valve into service.

### 6.1 Adjust valve

- The procedures described in this chapter are related to the adjustments on the main gas valve.
- For adjustments on the other additional functionalities (e.g. pressure switch), refer to the included instruction sheet of the product in question in the package.

### **⚠ WARNING**

Incorrect installation

Please observe the following to ensure that the unit is not damaged during adjustment and operation:

- Adjustments must be made by qualified personnel only.
- To ensure a safe closing of the valves, it is essential that voltage over the terminals of operators is reduced to 0 Volts.

### 2nd valve = fast opening

Flow rate can be adjusted.

### 2nd valve = slow opening

The following characteristics can be adjusted.

- Flow rate
- Step pressure
- Opening speed

### Important

- To ensure a satisfactory setting of the valve the pressure drop over the valve should be at least 10% of the supply pressure or 2,5 mbar whichever ever is the greatest.

### 6.2 Adjust valve

- The procedures described in this chapter are related to the adjustments on the main gas valve.

- For adjustments on the other additional functionalities (e.g. pressure switch), refer to the included instruction sheet of the product in question in the package.

### **⚠ WARNING**

Incorrect installation

Please observe the following to ensure that the unit is not damaged during adjustment and operation:

- Adjustments must be made by qualified personnel only.
- To ensure a safe closing of the valves, it is essential that voltage over the terminals of operators is reduced to 0 Volts.

### 2nd valve = fast opening

Flow rate can be adjusted.

### Important

- To ensure a satisfactory setting of the valve the pressure drop over the valve should be at least 10% of the supply pressure or 2,5 mbar whichever ever is the greatest.

### 6.3 Adjust flow rate

#### 2nd valve = fast opening

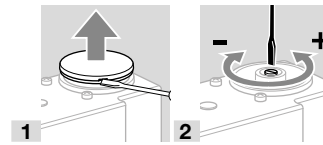

- 1
- 2
- 3 Turn adjustment screw counter-clockwise to increase or clockwise to decrease the flow rate.
- 4 Replace cap on top of the coil.

## 7 ADJUST SERVO REGULATOR

### **⚠ WARNING**

Incorrect adjustment

Please observe the following to ensure that the unit is not damaged during adjustment and operation:

- If the appliance manufacturer supplies checkout and/ or service and maintenance instructions carefully follow them. If these instructions are not provided, follow the procedure described below.
- In some applications, adjustment screws are sealed as well, to avoid drift of factory calibration during transportation. These sealings can be broken when needed for readjustments, but only by trained and authorized technicians.

## 7.1 Adjust gas/air 1:1 regulation

### **⚠ WARNING**

Incorrect adjustment

High inlet pressures as used for gas G30 or G31, can cause oscillation. This is dependent on type of appliance. If oscillation occurs:

- The oscillation shall not exceed 10 % of the outlet pressure, with a stable air pressure signal.
- The oscillation has to be verified for the complete modulation band of the appliance.
- Please contact your Honeywell representative if the maximum of 10 % is exceeded.

The 1:1 gas/air regulator assembly has an air pressure connection and an offset adjustment screw.

The 1:1 gas/air regulator equals the gas pressure to the supplied air pressure. With the offset adjustment screw it is possible to adjust the offset. (Offset =  $P_{\text{gas}} - P_{\text{air}}$ )

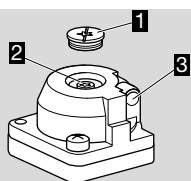

**1** Cap screw

**2** Offset adjustment screw

**3** M5 pressure feedback connection

**1** With the valve in the final mounting position, adjust the venturi fan for the lowest burner firing rate.

**2** Remove cap screw with a torque bit (or slotted screwdriver) to expose offset adjustment screw.

**3** Using a torque bit T40 or a 5 mm hex wrench, carefully adjust the low fire gas setting for proper combustion.

**4** After proper low fire offset adjustment has been made, replace cap screw and tighten pressure taps.

**5** Before commissioning the burner, check for proper lightoff and verify correct fuel/air mix and combustion quality through out the entire firing range (from lowest to highest fan speeds used).

### **Checkout of adjustment**

**6** After any adjustment check pressure taps and gas connections with an approved leak detection fluid for gas leakage.

**7** After any adjustment set appliance in operation and observe several complete cycles to ensure that all burner components function correctly.

### **7.1.1 Specify application parameters (gas/air 1:1)**

Define maximum allowable deviation on  $\Delta P_{\text{gas}}$  at minimum  $\Delta P_{\text{air}}$  in new appliance for reliability reasons.

The application parameters can effect the Offset Adjustment accuracy during cycling and life cycling of the control system.

These parameters are (in sequence of importance):

- Start pressure (the lower the better)
  - Ambient temperature (the lower the better)
- It is therefore advisable to verify the offset adjustment at service interval by  $\text{CO}_2$  measurement or  $\Delta P_{\text{gas}}$  (burner orifice pressure drop) at minimum  $\Delta P_{\text{air}}$  (pressure drop over air restriction).  $\Delta P_{\text{gas}}$  measured on pressure tap of combination gas control (highest pressure) can deviate from real  $\Delta P$  (burner orifice pressure drop) due to gas turbulence and/or restrictions in the application. The deviation should be defined and documented. The measurement accuracy should be +/- 1 Pa.

## 8 MAINTENANCE

### **⚠ WARNING**

Explosion hazard and electrical shock hazard!

Can cause severe injury, death or property damage.

- Turn off gas supply and disconnect all electrical power to the valve before servicing.
- Only trained, experienced, flame safeguard technicians should attempt to service or repair flame safeguard controls and burner assemblies.

### **Scheduled Inspection and Maintenance**

→ Set up and follow a schedule for periodic inspection and maintenance, including the burner, all other controls and the valves.

→ It is recommended that the valve leak test in the Checkout section be included in this schedule. Refer to the instructions for the primary safety control (s) 0 for more inspection and maintenance information.

**1** Make sure the gas supply is turned off and all electrical power has been removed.

**2** Remove bolts/nuts from flange/valve.

**3** Remove flange from gas supply pipe.

**4** Remove old screen/strainer

**5** Clean the strainer by using compressed air, or replace the strainer.

**6** Install the cleaned strainer or new strainer.

**7** Make sure O-ring sealing surface is clean on the flange.

**8** Using general purpose lithium grease, grease the O-ring.

**9** Apply a moderate amount of good quality pipe dope, resistant to the action of LP gas, only on the pipe threads.

**10** Install the O-ring in the O-ring groove provided on the flange/valve body (one O-ring per groove).

**11** Screw the flange onto the pipe.

**12** Mount the gas valve to the flange, using the bolts and nuts for each flange.

**13** Apply power to the valve.

**14** Turn on the main gas supply.

**15** Complete the valve leak test.

**16** Return the valve to service.



## 9 TROUBLESHOOTING

### **⚠ WARNING**

Risk of injury!

Can cause severe injury, death of property damage.

- Use extreme caution when troubleshooting; line voltage is present.
- Do not replace the valve until all other sources of trouble are eliminated.

### **? Fault**

#### **! Cause**

- Remedy

### **? The valve does not open when the thermostat or controller calls for heat?**

#### **! No voltage at the valve lead wires.**

- Check for voltage at the valve lead wires or terminal block.

#### **! If there is no voltage at the valve lead wires or terminal block.**

- Make sure, that voltage is connected to the master switch.
- Make sure, that the master switch is closed and overload protection (circuit breaker, fuse, or similar device) has not opened the power line.

#### **! There is still no voltage at the valve lead wires.**

- If there is still no voltage at the valve leadwires or terminal block, make sure all appropriate contacts in the thermostat or controller, limits and flame safeguard control are closed. If one or more are open, determine the cause(s); correct the trouble and proceed.

#### **! There is proper voltage at the valve but the valve still does not open.**

- check for normal gas pressure.

#### **! Is it not possible for the fault to be eliminated with the measures described above?**

- Remove the unit and return it to the manufacturer for inspection.

### **? If the valve does not close when one or more of the appropriate contacts in the thermostat, controller, limits or flame safeguard control is open.**

#### **! Is the valve connected in the correct circuit?**

- Make sure the valve is wired in the correct circuit

#### **! Valve is not wired correctly.**

- Open the master switch to remove power from the valve. If the valve closes now, check the wiring for the valve and correct the wiring as necessary.

#### **! Is there a short circuit?**

- Check for a short in the electrical circuit and repair it as necessary.

## 10 ACCESSORIES

### 10.1 Flange kit

Inlet flanges and outlet flanges are available as accessories. Valve comes with one kit only.

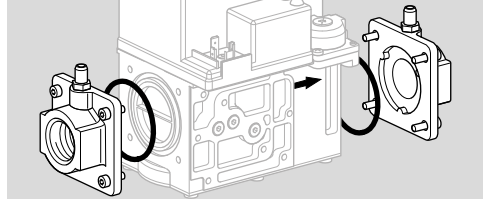

Scope of delivery:

- 1 flange with sealing plug,
- 1 "O"-ring and screws,
- 1 pressure tap nipple fitted

Flange kits

Pressure tap included?

Part number	Size (NPT)	Remarks
32006652-001	1/2"	pressure tap 1/8"
32006652-002	3/4"	pressure tap 1/8"
32006652-003	1"	pressure tap 1/8"
32006652-004	1¼"	pressure tap 1/8"

### 10.2 Valve connection plug

Electrical connections Standard DIN plug connector according DIN 43650 (Form A)

-CO020012 (black). Not included.

### 10.3 Mixing unit VMU

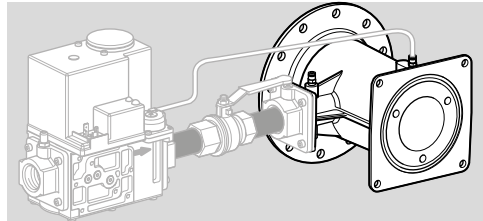

Integrated gas/air 1:1 with venturi mixing unit, see instruction sheet VMU "Mixing unit for V473xC/V8743xC gas controls" (65-0282) [www.docuthek.com](http://www.docuthek.com).

### 10.4 Venturi-mounting-kit

For flange mounting the Venturi VMU. Order no.: 32006653-001.

Scope of delivery: O-rings/screws.

## 10.5 Sensing tube VMU

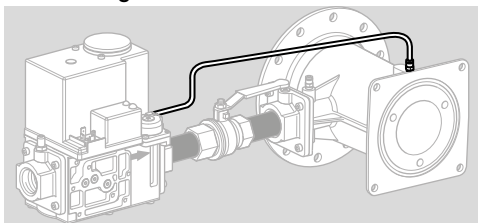

Short Sensing Tube for VMU150/300/335 kW Venturi Mixing Units. Order No.: KTTBA001.

Long Sensing Tube for VMU500 kW Venturi Mixing Unit. Order No.: KTTBA002.

## 10.6 Manual Shut-Off Valve

Manual Shut-Off Valve Kits can be ordered to provide manual shut-off function.

Order no.: 50002653-001, for 1 inch NPT or smaller valves.

Order no.: 50002653-002, for 1-1/4 inch NPT valve.

## 10.7 Pressure switch for gas C60VR4

The pressure switch for gas monitors the inlet pressure or the intermediate pressure.

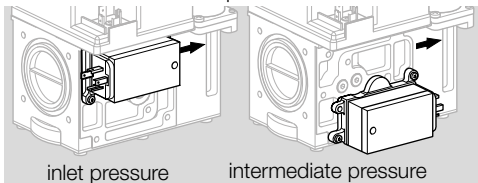

Scope of delivery:

- 1 x pressure switch for gas,
- 2 x self-tapping retaining screws,
- 1 x sealing ring,
- 1 x protection cap.

### 10.7.1 Pressure switch connection plug

Electrical connections Standard DIN plug connector according DIN 43650 (Form A) -CO020014 (gray). Not included.

### 10.7.2 Adjust switching point

→ The switching point is adjustable via hand wheel.

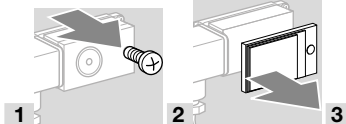

Type	Adjusting range (adjusting tolerance = ± 15% of the scale value)		Mean switching differential at min. and max. setting	
	[mbar]	[\"WC]	[mbar]	[\"WC]
C60VRT40040	5-40	2-16	1-2	0,4-1

→ Deviation from the switching point during testing pursuant to EN 1854 Gas pressure switches: ± 15%.

## 11 TECHNICAL DATA

The specifications in this section are related to the Venturi Mixing Unit (VMU) and Combination Gas Valve.

Valve and flange size:

Type	Valve size	Flange size
V4730C1006	1/2"	1/2"
V4730C1014	3/4"	3/4"
V4730C1022	1"	1"
V4730C1030	1"	1 1/4"
V4734C1002	1 1/4"	1 1/4"
V8730C1007	1/2"	1/2"
V8730C1015	3/4"	3/4"
V8730C1023	1"	1"
V8730C1031	1"	1 1/4"

Power consumption:

Type	Voltage	V1 + V2, total current
V4730C1006 V4730C1014	120V AC, 50/60 Hz	0.26 A
V4730C1022 V4730C1030	120V AC, 50/60 Hz	0.46 A
V4734C1002	120V AC, 50/60 Hz	0.8 A at startup (0.26 A <sup>1)</sup> )
V8730C1007 V8730C1015	24V AC, 50/60 Hz	1.28 A
V8730C1023 V8730C1031	24V AC, 50/60 Hz	3.0 A

1) First value during start up, second value during normal operation

## Capacity:

Type	VMU	Capacity (natural gas 0.64 kg/m <sup>3</sup> )
V4730C1006	150	22–150 kW (73–512 kBtu/hr)
V4730C1014	185	26–185 kW (89–622 kBtu/hr)
V4730C1022	300	43–300 kW (144–1009 kBtu/hr)
V4730C1022	335	48–335 kW (161–1127 kBtu/hr)
V4730C1030	300	43–300 kW (144–1009 kBtu/hr)
V4730C1030	335	48–335 kW (161–1127 kBtu/hr)
V4734C1002	400	55–382 kW (185–1300 kBtu/hr)
V4734C1002	500	71–500 kW (245–1710 kBtu/hr)
V4734C1002	680	97–680 kW (326–2287 kBtu/hr)
V8730C1007	150	22–150 kW (73–512 kBtu/hr)
V8730C1015	185	26–185 kW (89–622 kBtu/hr)
V8730C1023	300	43–300 kW (144–1009 kBtu/hr)
V8730C1023	335	48–335 kW (161–1127 kBtu/hr)
V8730C1031	300	43–300 kW (144–1009 kBtu/hr)
V8730C1031	335	48–335 kW (161–1127 kBtu/hr)

## Maximum operating pressure (UL)

1.45 psi (100 mbar),

except for 1-1/4 inch size:

(24V): 1 psi (70 mbar),

(120V): 1.45 psi (100 mbar).

CSA Approved to 0.5 psi (34 mbar).

Torsion and bending stress

Pipe connections meet group 2 according to

EN 13611 requirements.

Electrical connections:

Standard plug connector (according DIN 43650)  
with 36 inch (914 mm) lead wires.

Valve position indicator lamps:

Inboard (closest to the valve body) - V1.

Outboard - V2.

Ambient temperature range:

5 to +140 °F (-15 to +60°C)

Storage temperature = transport temperature:

-20 to +40 °C (-4 to +104 °F).

Coil insulation solenoid valves:

Class F insulation system.

Body Material:

Aluminum alloy, die-cast.

Strainer:

Fine mesh screen (0.135 in. [0.34 mm] diameter).

AISI 303 steel, serviceable after removing inlet flange

screws. Meets EN161 requirements for strainers.

## Seals and Gaskets:

Hydrocarbon-resistant NBR and Viton rubber types.

Enclosure: NEMA 1 (IP 40)

## 11.1 Tightening torque

Recommended tightening torques for the connection parts:

Screw type	Tightening torque
Throttle screw adjustment	max. 4.4 lb-in min. 0.35 lb-in
Flanges	max. 8.8 lb-in min. 0.04 lb-in
Pressure tap plug	62 ± 8.8 lb-in
Pressure switch mounting	22 ± 13 lb-in
Pressure switch cover	10.6 ± 1.8 lb-in
Inlet/outlet flange screw	38 ± 3.5 lb-in

## 11.2 Performance characteristics

Opening time:

Dead time maximum 1 second.

First valve opening: <0,5 second.

Second valve opening: reaches 50% of the adjustable outlet pressure within 5 seconds.

Maximum allowable leakage:

Outerwall, safety valve and main valve = 2.5 inch<sup>3</sup>/h (40 cm<sup>3</sup>/h for upto DN 25 and 3 inch<sup>3</sup>/h (50 cm<sup>3</sup>/h) for DN 32 at test pressure of 0.87 psi (6 mbar) and 1.5 x maximum operating pressure.

High pressure test:

In the "OFF" condition, the valve will withstand 21.75 psi (1.5 bar) inlet pressure without damage.

Operational voltage range:

The combination gas valve will function satisfactorily between 85% and 110% of the rated voltage.

Gas Valve Connection to Venturi (Field-Assembled):

Four screws and an O-ring are used to connect the gas valve to the venturi/manual shutoff valve.

The metal tube provided with the venturi must be connected between the venturi and the gas valve regulator.

Fan Connection:

The venturi is connected to the fan using six bolts (which are included with VMU).

Minimum Load:

The minimum load for which the system can be used is 14–17% of the reference load, which equals a minimum pressure differential of 0.2 inch WC (50 Pa) of the 1:1 venturi/servo regulator gas control.

### 11.3 Hi-lo regulator

Pressure feedback connection:

The high-low regulator with an M5 thread connection for pressure feedback.

Minimum regulation capacity:

0,31 m<sup>3</sup>/h

Maximum operating pressure:

The maximum pressure  $P_{max}$  indication on the housing of the combination gas control is the maximum pressure at which it functions safely.

However, the maximum operating pressure is limited by the pressure range of the high-low pressure regulator concerned: 50 mbar for pressure range 4–37.

Electrical connection:

The high-low coil is provided with an earth terminal.

The high-low coil is provided with quick connect terminals suitable for 6,3 mm.

Connector: DIN 43650 From B

Regulator output pressure range:

Pressure range (mbar)	Setting	
	low	high
4–37	4 - $P_{max}$ ( $P_{max} < P_{high}$ )	12–37

Electrical data:

Supply voltage	Color of coil	Current (mA)	Power consumption
220/240 V~, 50 Hz	black	17,4/19	3/3,2

## 12 CERTIFICATION

### 12.1 Certificate download

Certificates – see [www.docuthek.com](http://www.docuthek.com)

### 12.2 UL recognized



UL429 Electrically operated valves

## FOR MORE INFORMATION

The Honeywell Thermal Solutions family of products includes Honeywell Combustion Safety, Eclipse, Exothermics, Hauck, Kromschroder and Maxon. To learn more about our products, visit [ThermalSolutions.honeywell.com](http://ThermalSolutions.honeywell.com) or contact your Honeywell Sales Engineer.

Honeywell Process Solutions  
Honeywell Thermal Solutions (HTS)  
2101 CityWest Blvd  
Houston, TX 77042  
United States  
[ThermalSolutions.honeywell.com](http://ThermalSolutions.honeywell.com)

## 13 LOGISTICS

### Transport

Protect the unit from external forces (blows, shocks, vibration).

Transport temperature: see page 10 (11 Technical data).

Transport is subject to the ambient conditions described.

Report any transport damage on the unit or packaging without delay.

Check that the delivery is complete.

### Storage

Storage temperature: see page 10 (11 Technical data).

Storage is subject to the ambient conditions described.

Storage time: 6 months in the original packaging before using for the first time. If stored for longer than this, the overall service life will be reduced by the corresponding amount of extra storage time.

## 14 DISPOSAL

Devices with electronic components:

### WEEE Directive 2012/19/EU – Waste Electrical and Electronic Equipment Directive



At the end of the product life (number of operating cycles reached), dispose of the packaging and product in a corresponding recycling centre. Do not dispose of the unit with the usual domestic refuse. Do not burn the product.

On request, old units may be returned carriage paid to the manufacturer in accordance with the relevant waste legislation requirements.

# Honeywell