

Eclipse ThermJet

Self-Recuperative Burners

Models TJSR0020 - TJSR0100

Version 5

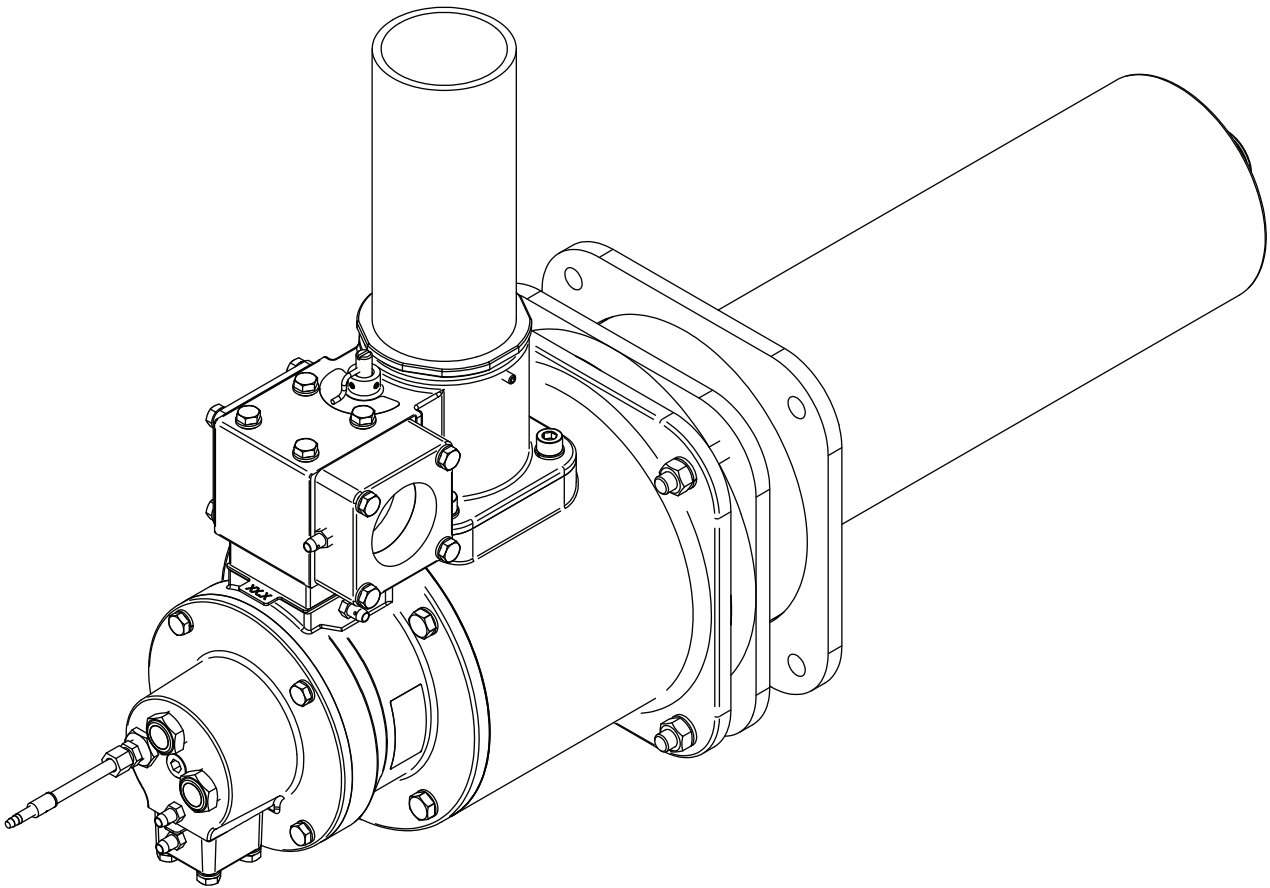

Copyright

Copyright 2010 by Eclipse, inc. All rights reserved worldwide. This publication is protected by federal regulation and shall not be copied, distributed, transmitted, transcribed or translated into any human or computer language, in any form or by any means, to any third parties, without the express written consent of Eclipse, inc.

Disclaimer Notice

In accordance with the manufacturer's policy of continual product improvement, the product presented in this brochure is subject to change without notice or obligation.

The material in this manual is believed adequate for the intended use of the product. If the product is used for purposes other than those specified herein, confirmation of validity and suitability must be obtained. Eclipse warrants that the product itself does not infringe upon any United States patents. No further warranty is expressed or implied.

Liability & Warranty

We have made every effort to make this manual as accurate and complete as possible. Should you find errors or omissions, please bring them to our attention so that we may correct them. In this way we hope to improve our product documentation for the benefit of our customers. Please send your corrections and comments to our Technical Documentation Specialist.

It must be understood that Eclipse's liability for its product, whether due to breach of warranty, negligence, strict liability, or otherwise is limited to the furnishing of replacement parts and Eclipse will not be liable for any other injury, loss, damage or expenses, whether direct or consequential, including but not limited to loss of use,

income, or damage to material arising in connection with the sale, installation, use of, inability to use, or the repair or replacement of Eclipse's products.

Any operation expressly prohibited in this manual, any adjustment, or assembly procedures not recommended or authorized in these instructions shall void the warranty.

Document Conventions

There are several special symbols in this document. You must know their meaning and importance.

The explanation of these symbols follows below. Please read it thoroughly.

How To Get Help

If you need help, contact your local Eclipse representative. You can also contact Eclipse at:

1665 Elmwood Rd.
Rockford, Illinois 61103 U.S.A.
Phone: 815-877-3031
Fax: 815-877-3336
<http://www.eclipsenet.com>

Please have the information on the product label available when contacting the factory so we may better serve you.

 ECLIPSE <small>Innovative Thermal Solutions</small>	www.eclipsenet.com
Product Name	
Item #	
S/N	
DD MMM YYYY	



This is the safety alert symbol. It is used to alert you to potential personal injunt hazards. Obey all safety messages that follow this symbol to avoid possible injury or death.



Indicates a hazardous situation which, if not avoided, will result in death or serious injury.



Indicates a hazardous situation which, if not avoided, could result in death or serious injury.



Indicates a hazardous situation which, if not avoided, could result in minor or moderate injury.

NOTICE

Is used to address practices not related to personal injury.

NOTE

Indicates an important part of text. Read thoroughly.



Table of Contents

1 Introduction	4
Product Description	4
Audience	4
Purpose	4
ThermJet Self-Recuperative Documents	4
Related Documents.....	4
2 Safety	5
Safety Warnings	5
Capabilities.....	5
Operator Training	5
Replacement Parts.....	5
3 System Design	6
Design	6
Step 1: Burner Model Selection.....	6
Step 2: Control Methodology.....	6
Step 3: Ignition System	9
Step 4: Flame Monitoring Control System.....	9
Step 5: Combustion Air System	9
Step 6: Main Gas Shut-Off Valve Train	10
Appendix	i
Conversion Factors	i
Key to System Schematics.....	ii

Introduction

1

Product Description

The ThermJet Self-Recuperative burner is a nozzle mix burner that is designed to fire an intense stream of hot gases through a combustor. It includes an integral recuperator and integral eductor to draw exhaust gases through the burner and preheat combustion air. The air requirements for both the eductor and the burner are met by a single air connection.

The high velocity of the gases improves temperature uniformity, product quality and system efficiency.

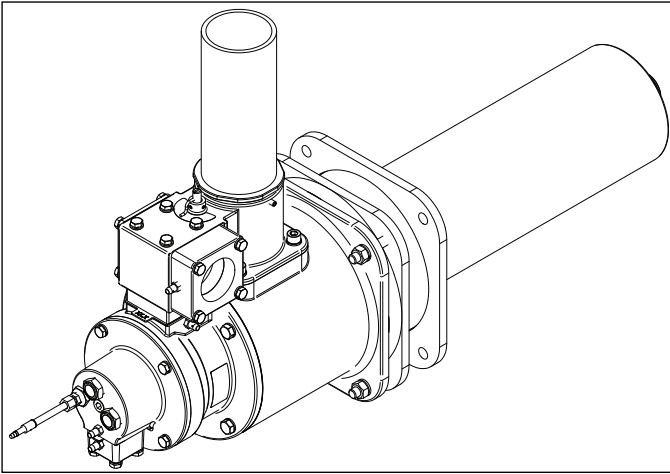

Figure 1.1. Eclipse ThermJet Self-Recuperative Burner

Audience

This manual has been written for personnel already familiar with all aspects of a nozzle mixing burner and its add-on components, also known as “the burner system”.

These aspects are:

- Installation
- Use
- Maintenance
- Safety

The audience is expected to be qualified and have experience with this type of equipment and its working environment.

Purpose

The purpose of this manual is to make sure that you carry out the installation of a safe, effective, and trouble-free system.

ThermJet Self-Recuperative Documents

Design Guide No. 208

- This document

Datasheet No. 208-1 through 208-4

- Available for individual ThermJet Self-Recuperative models
- Required to complete design and selection

Installation Guide No. 208

- Used with Datasheet to complete installation

Worksheet No. 208

- Required to provide application information to Eclipse Engineering

Spare Parts List Series No. 208

- Recommended replacement part information

Related Documents

- EFE 825 (Combustion Engineering Guide)
- Eclipse Bulletins and Info Guides: 610, 710, 720, 730, 742, 744, 760, 930

Safety

Important notices which help provide safe burner operation will be found in this section. To avoid personal injury and damage to the property or facility, the following warnings must be observed. All involved personnel should read this entire manual carefully before attempting to start or operate this system. If any part of the information in this manual is not understood, contact Eclipse before continuing.

Safety Warnings



DANGER

- **The burners, described herein, are designed to mix fuel with air and burn the resulting mixture. All fuel burning devices are capable of producing fires and explosions if improperly applied, installed, adjusted, controlled or maintained.**
- **Do not bypass any safety feature; fire or explosion could result.**
- **Never try to light a burner if it shows signs of damage or malfunction.**



WARNING

- **The burner and duct sections are likely to have HOT surfaces. Always wear the appropriate protective equipment when approaching the burner.**
- **Eclipse products are designed to minimize the use of materials that contain crystalline silica. Examples of these chemicals are: respirable crystalline silica from bricks, cement or other masonry products and respirable refractory ceramic fibers from insulating blankets, boards, or gaskets. Despite these efforts, dust created by sanding, sawing, grinding, cutting and other construction activities could release crystalline silica. Crystalline silica is known to cause cancer, and health risks from the exposure to these chemicals vary depending on the frequency and length of exposure to these chemicals. To reduce the risk, limit exposure to these chemicals, work in a well-ventilated area and wear approved personal protective safety equipment for these chemicals.**

NOTICE

- **This manual provides information regarding the use of these burners for their specific design purpose. Do not deviate from any instructions or application limits described herein without written approval from Eclipse.**

Capabilities

Only qualified personnel, with sufficient mechanical aptitude and experience with combustion equipment, should adjust, maintain or troubleshoot any mechanical or electrical part of this system. Contact Eclipse for any needed commissioning assistance.

Operator Training

The best safety precaution is an alert and trained operator. Train new operators thoroughly and have them demonstrate an adequate understanding of the equipment and its operation. A regular retraining schedule should be administered to ensure operators maintain a high degree of proficiency. Contact Eclipse for any needed site-specific training.

Replacement Parts

Order replacement parts from Eclipse only. All Eclipse approved valves or switches should carry UL, FM, CSA, CGA and/or CE approval where applicable.

System Design

3

Design

When selecting a ThermJet Self-Recuperative burner, choices are available to define a burner that will be safe and reliable for the system in which it will be installed. The design process is divided into the following steps:

1. Burner Model Selection Including:
 - Burner Model / Size Selection
 - Desired Efficiency
 - Fuel Type and Pressure
2. Control Methodology
3. Ignition System
4. Flame Monitoring System
5. Combustion Air System:
 - Blower Motor Type
 - Air Pressure Switch
6. Main Gas Shut-Off Valve Train Selection

Step 1: Burner Model Selection

Burner Model / Size Selection

Select the size and number of burners based on the heat balance. For heat balance calculations, refer to the Combustion Engineering Guide (EFE 825).

Performance data, dimensions, and specifications are given for each ThermJet Self-Recuperative model in datasheet series 208.

Desired Efficiency

Smaller capacity burners are more efficient than larger models. Firing at lower inputs also result in higher efficiency.

Fuel Type and Fuel Pressure

The standard fuel is Natural Gas.

Fuel	Symbol	Gross Heating Value	Specific Gravity	WOBBE Index
Natural Gas	CH ₄ 90%+	1000 BTU/ft ³ (40.1 MJ/m ³)	0.60	1290 BTU/ft ³
BTU/ft ³ @ standard conditions (MJ/m ³ @ normal conditions)				

If using an alternative fuel supply, contact Eclipse with an accurate breakdown of the fuel components.

The minimum required gas pressure at the burner can be found in the ThermJet Self-Recuperative datasheets series 208.

Step 2: Control Methodology

The control methodology is the basis for the rest of the design process. Once the system is designed, the components can be selected. The control methodology chosen depends on the requirements of the process.

NOTE: The stated operational characteristics only apply if the described control circuits are followed. Use of different control methods will result in unknown operational performance characteristics. Use the control circuits contained within this section or contact Eclipse for written, approved alternatives.

Control Method

Eclipse recommends the high/low pulse method to control the input of a ThermJet Self-Recuperative burner system. The high/low control method is high/low air and gas biased control with excess air at low fire (pulse firing). A related control method, high/low/off, may also be employed where additional turndown is required. These methods may be applied to single burner as well as multiple burner systems.

In the pages that follow you will find schematics of these control methods. The symbols in the schematic are explained in the "Key to System Schematics", see Appendix.

Modulating control may also be accommodated, contact Eclipse with details for your application.

NOTE: The following control method does not illustrate flame safety. Flame safety is discussed in Step 4 on page 9 of this guide. Any decisions regarding the use and/or type of flame safety should be made in accordance with local safety and/or insurance requirements.

NOTE: Eclipse recommends using a Dungs FRG Ratio Regulator on all applications. All settings given in the Installation Guide are based on use of the Dungs Ratio Regulator. Use of a different ratio regulator may result in improper burner operation.

High/Low Control

The firing rate is adjusted at two positions, the high and low fire set points. The burner remains on during the full process cycle. When the system is set to high/low control:

1. Manual butterfly valve sets high fire air flow rate.
2. Solenoid valve opens for high fire air flow and closes for low fire air flow.
3. Manual butterfly valve sets low fire bypass air flow.
4. Manual butterfly valve balances the air flow for burner (multiple burner installation).
5. Ratio regulator adjusts gas flow as loading line pressure changes due to air pressure changes.
6. Manual butterfly valve sets high fire gas flow.

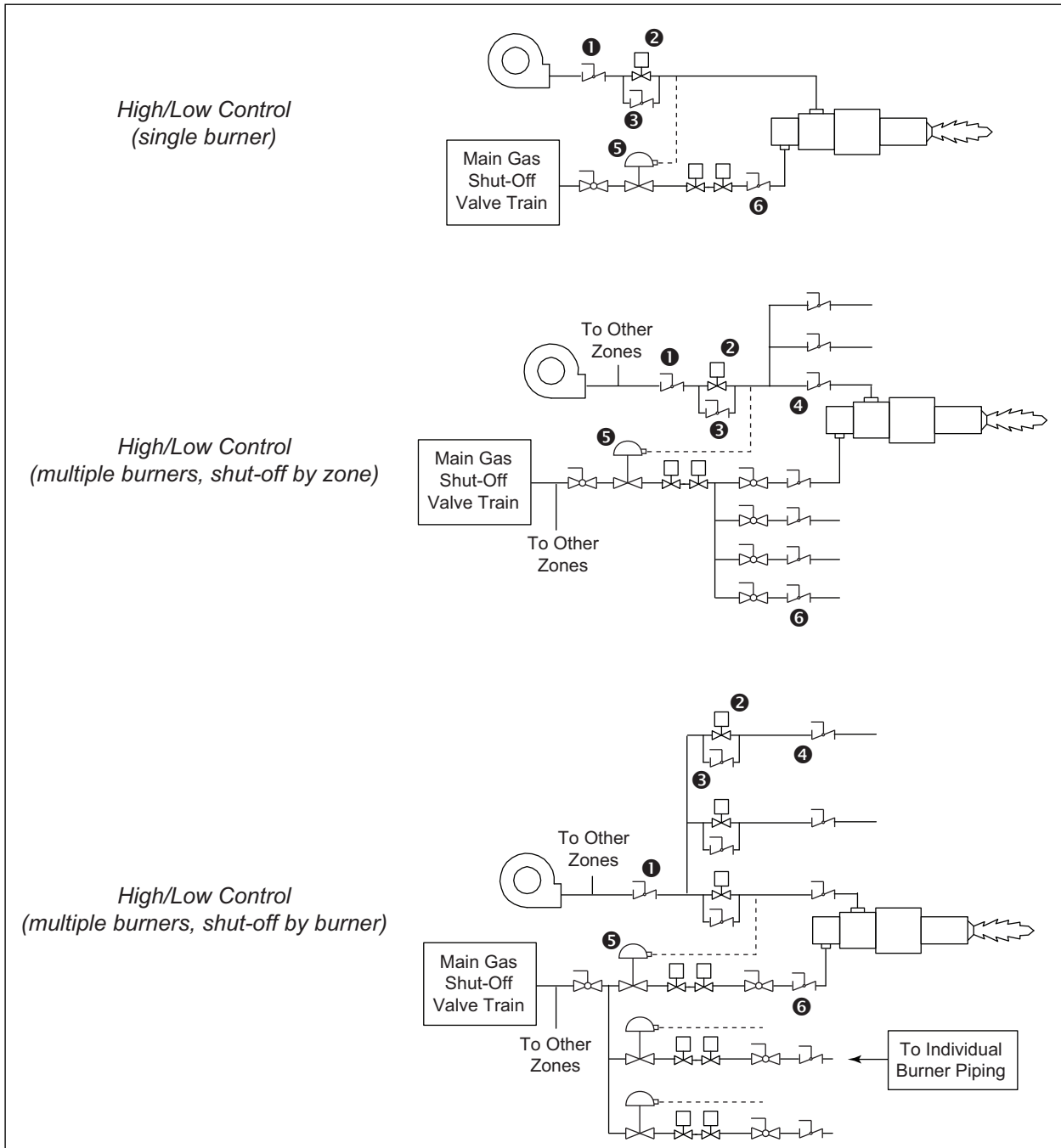

Figure 3.1 High/Low Control

High/Low/Off Control

The firing rate is set to two positions, the high and low fire set points, or the burner is shut off. The off state is used when the low fire rate causes the process temperature to continue to rise. The setup is the same as high/low control, but the solenoid is used not only as a flame safety mechanism, but also for temperature control. When the system is set to high/low/off control:

1. Manual butterfly valve sets high fire air flow rate.
2. Solenoid valve opens for high fire air flow and closes for low fire air flow.
3. Manual butterfly valve sets low fire bypass air flow.
4. Manual butterfly valve balances the air flow for burner (multiple burner installations).
5. Ratio regulator adjusts gas flow as loading line pressure changes due to air pressure changes.
6. Solenoid valve closes if low fire temperature is too high.
7. Manual butterfly valve sets high fire gas flow.

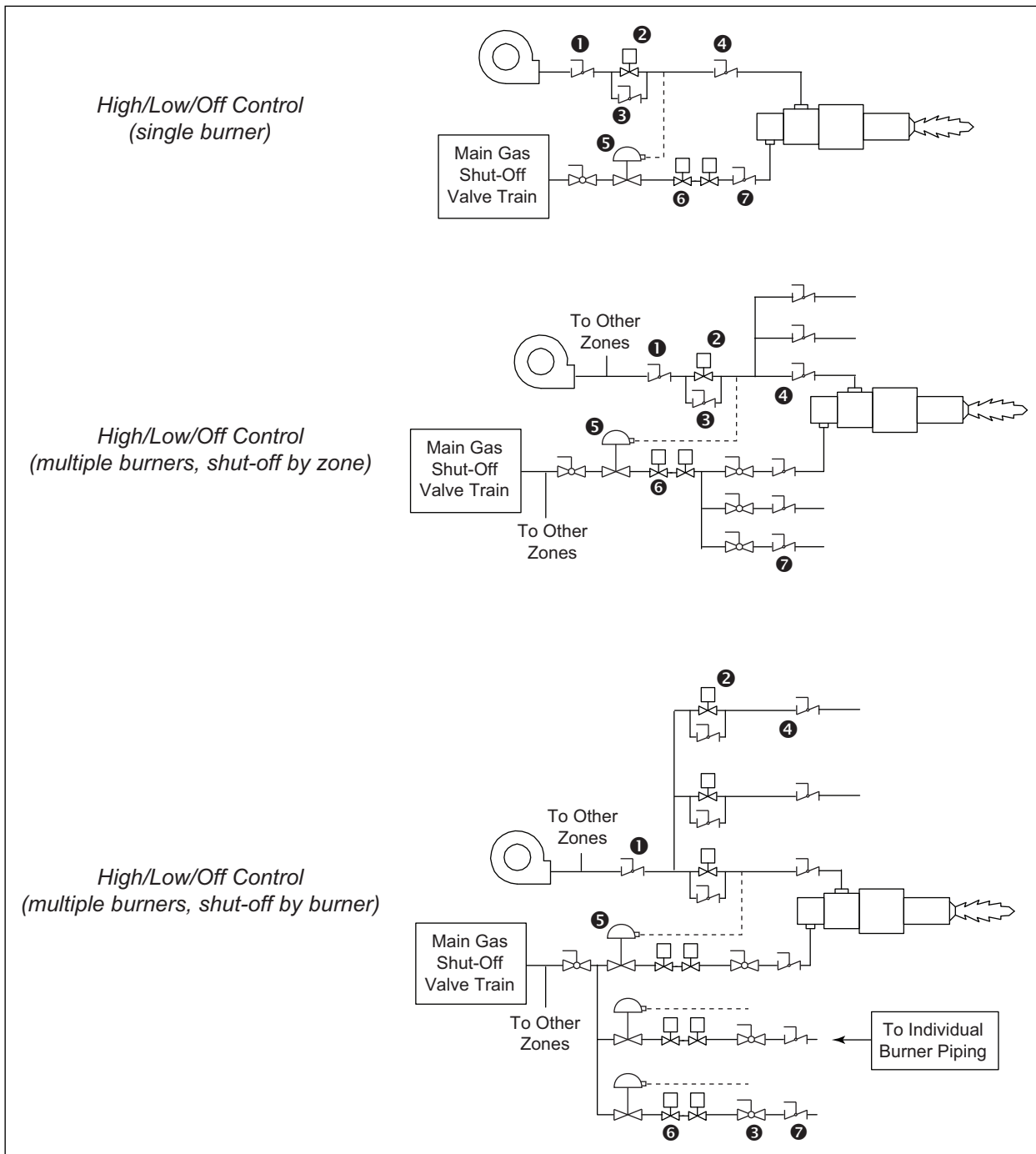

Figure 3.2 High/Low/Off Control

Step 3: Ignition System

Ignition Transformer

For the ignition system, use a transformer with:

- 6000 VAC transformer
- full-wave spark
- one transformer per burner

DO NOT USE the following:

- 10000 VAC transformer
- twin outlet transformer
- distributor type transformer
- half-wave transformer

Eclipse recommends a low fire start be used. However, ThermJet Self-Recuperative burners are capable of direct spark ignition anywhere within the operating range. See the Installation Guide for detailed start information.

NOTE: You must follow the control circuits described in the previous section, “Control Methodology”, to obtain reliable ignition.

Local safety and insurance require limits on the maximum trail for ignition time. These time limits vary from country to country.

The time it takes for a burner to ignite depends on:

- the distance between the gas shut-off valve and the burner
- the air/gas ratio
- the gas flow at start conditions

It is possible to have the low fire too low to ignite within the trail for ignition period. Under these circumstances you must consider the following options:

- start at higher input levels
- resize and/or relocate the gas controls
- use bypass start gas

Step 4: Flame Monitoring Control System

The flame monitoring control system consists of two main components:

- flame sensor
- flame monitoring control

Flame Sensor

UV Scanners can be used on ThermJet Self-Recuperative burners.

The UV scanner must be compatible to the flame monitoring control that is used. Refer to the manual of your selected control for proper selection of the scanner.

Flame Monitoring Control

The flame monitoring control processes the signal from the flame sensor and controls the start-up and shut-down sequences.

Eclipse recommends the following flame monitoring controls:

- Trilogy series T400 (Instruction Manual 830)
- Veri-Flame series 5600 (Instruction Manual 818)
- Bi-Flame series 6500 (Instruction Manual 826)
- Multi-Flame series 6000 (Instruction Manual 820)

If other controls are considered, contact Eclipse to determine how burner performance may be affected. Flame monitoring controls that have lower sensitivity flame detecting circuits may limit burner turndown and change the requirements for ignition.

Flame monitoring controls that stop the spark as soon as a signal is detected may prevent establishment of flame, particularly when using UV scanners. The flame monitoring control must maintain the spark for a fixed time interval that is long enough for ignition.

Step 5: Combustion Air System

Blower Motor Type

Effects of Atmospheric Conditions

The blower data is based on the International Standard Atmosphere (ISA) at Mean Sea Level (MSL), which means that it is valid for:

- sea level
- 29.92" Hg (1013 mbar)
- 70°F (21°C)

The makeup of the air is different above sea level or in a hot environment. The density of the air decreases, and as a result, the outlet pressure and the flow of the blower decrease. An accurate description of these effects is in the Eclipse Combustion Engineering Guide (EFE 825). The guide contains tables to calculate the effect of pressure, altitude and temperature on air.

Blower

The rating of the blower must match the system requirements. You can find all the blower data in Bulletin/Info Guide 610.

1. Calculate the Outlet Pressure

When calculating the required outlet pressure of the blower, the total of these pressures must be calculated.

- the static air pressure required at the burner
- the total pressure drop in the piping
- the total of the pressure drops across the valves
- a minimum safety margin of 10%

2. Calculate the Blower Air Volume

The volume of air required will be dictated by the maximum output required from the burner. This will be the total of the air required for combustion plus the air required for the eductor. The totals required are shown on the appropriate datasheet. Multiply this volume by the number of burners and this is the total volume needed.

NOTE: A minimum of 10% safety margin should be added to the blower capacity.

Exhaust

The eductor provided with the TJSR is capable of pulling all the exhaust gas through the burner and when set up correctly will give approximately neutral pressure in the furnace chamber. Using this method it is not possible to use furnace pressure control.

An alternative method, where more precise furnace pressure control is required, is to pull only 90% of the exhaust gases through the burner. The remaining 10% of exhaust gas would exit through an auxiliary flue with furnace pressure control.

The furnace pressure should not be too high; a positive pressure will force a disproportionate amount of exhaust gases through burners that are in the off or low fire mode.

Exhaust ducting should not be connected directly to the eductor outlet. It's recommended that the exhaust duct or cowl be at least 2" larger in diameter than the eductor outlet. There should be at least a 2" vertical air gap.

Air Pressure Switch

The air pressure switch gives a signal to the monitoring system when there is not enough air pressure from the blower.

You can find more information on pressure switches in Blower Bulletin 610.



WARNING

- Eclipse supports NFPA regulations, which require the use of an air pressure switch in conjunction with other safety components, as a minimum standard for main gas safety shutoff systems.

Step 6: Main Gas Shut-Off Valve Train

Consult Eclipse

Eclipse can help you design and obtain a main gas shut-off valve train that complies with the current safety standards.

The shut-off valve train must comply with all the local safety standards set by the authorities that have jurisdiction.

For details, please contact your local Eclipse representative or Eclipse.

NOTE: Eclipse supports NFPA regulations (two shut-off valves) as a minimum standard for main gas safety shut-off systems.



Appendix

Conversion Factors

Metric to English

From	To	Multiply By
actual cubic meter/h (am ³ /h)	actual cubic foot/h (acfh)	35.31
normal cubic meter/h (Nm ³ /h)	standard cubic foot /h (scfh)	38.04
degrees Celsius (°C)	degrees Fahrenheit (°F)	(°C x 9/5) + 32
kilogram (kg)	pound (lb)	2.205
kilowatt (kW)	Btu/h	3415
meter (m)	foot (ft)	3.281
millibar (mbar)	inches water column ("w.c.)	0.402
millibar (mbar)	pounds/sq in (psi)	14.5 x 10 ⁻³
millimeter (mm)	inch (in)	3.94 x 10 ⁻²
MJ/Nm ³	Btu/ft ³ (standard)	26.86

Metric to Metric







From	To	Multiply By
kiloPascals (kPa)	millibar (mbar)	10
meter (m)	millimeter (mm)	1000
millibar (mbar)	kiloPascals (kPa)	0.1
millimeter (mm)	meter (m)	0.001



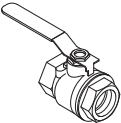
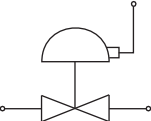
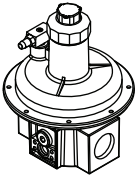
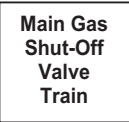

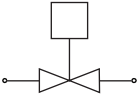
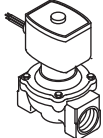



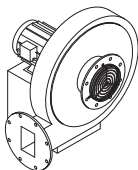

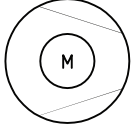
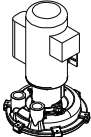
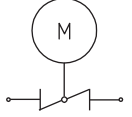
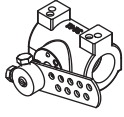
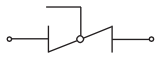
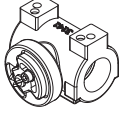
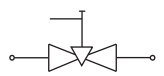

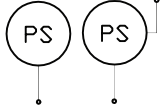

English to Metric

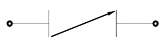
From	To	Multiply By
actual cubic foot/h (acfh)	actual cubic meter/h (am ³ /h)	2.832 x 10 ⁻²
standard cubic foot /h (scfh)	normal cubic meter/h (Nm ³ /h)	2.629 x 10 ⁻²
degrees Fahrenheit (°F)	degrees Celsius (°C)	(°F - 32) x 5/9
pound (lb)	kilogram (kg)	0.454
Btu/h	kilowatt (kW)	0.293 x 10 ⁻³
foot (ft)	meter (m)	0.3048
inches water column ("w.c.)	millibar (mbar)	2.489
pounds/sq in (psi)	millibar (mbar)	68.95
inch (in)	millimeter (mm)	25.4
Btu/ft ³ (standard)	MJ/Nm ³	37.2 x 10 ⁻³

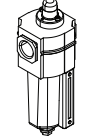

System Schematics

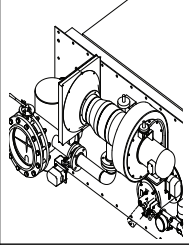
Symbol	Appearance	Name	Remarks	Bulletin/ Info Guide
		Gas Cock	Gas cocks are used to manually shut off the gas supply.	710
		Ratio Regulator	A ratio regulator is used to control the air/gas ratio. The ratio regulator is a sealed unit that adjusts the gas pressure in ratio with the air pressure. To do this, it measures the air pressure with a pressure sensing line, the impulse line. This impulse line is connected between the top of the ratio regulator and the burner body.	742
		Main Gas Shut-Off Valve Train	Eclipse strongly endorses NFPA as a minimum.	790/791
		Pilot Gas Valve Train	Eclipse strongly endorses NFPA as a minimum.	790/791
		Automatic Shut-Off Valve	Shut-off valves are used to automatically shut off the gas supply on a gas system or a burner.	760
		Orifice Meter	Orifice meters are used to measure flow.	930
		Combustion Air Blower	The combustion air blower provides the combustion air to the burner(s).	610

Symbol	Appearance	Name	Remarks	Bulletin/ Info Guide
		Hermetic Booster	Booster is used to increase gas pressure.	620
		Automatic Butterfly Valve	Automatic butterfly valves are typically used to set the output of the system.	720
		Manual Butterfly Valve	Manual butterfly valves are used to balance the air or gas flow at each burner.	720
		Adjustable Limiting Orifice	Adjustable limiting orifices are used for fine adjustment of gas flow.	728/730
		Pressure Switch	A switch activated by rise or fall in pressure. A manual reset version requires pushing a button to transfer the contacts when the pressure set point is satisfied.	840
		Pressure Gauge	A device to indicate pressure.	940
		Check Valve	A check valve permits flow only in one direction and is used to prevent back flow of gas.	780
		Strainer	A strainer traps sediment to prevent blockage of sensitive components downstream.	
		Flexible Connector	Flexible connectors isolate components from vibration, mechanical, and thermal stresses.	
		Heat Exchanger	Heat exchangers transfer heat from one medium to another.	500
		Pressure Taps	Pressure taps measure static pressure.	

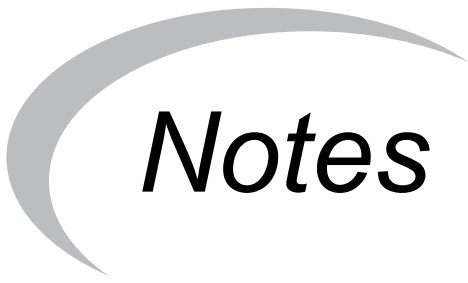

Notes

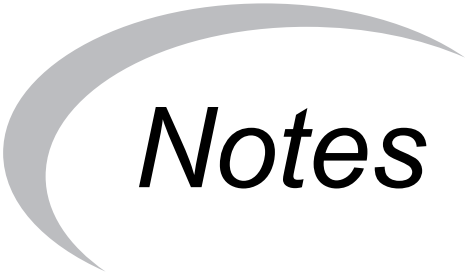

Notes

