

Motorized valves for gas VK

TECHNICAL INFORMATION

- Safety valves for gas
- Flow rate can be restricted
- Robust design for a long service life
- Energy-saving thanks to automatic motor shut-off
- Explosion-proof version available
- One- or two-stage, available with closed position indicator



Contents

Contents	2	8.1 Ambient conditions	20
1 Application	3	8.2 Mechanical data	20
1.1 Application examples	4	8.3 Electrical data	21
2 Certification	5	8.4 Dimensions	22
3 Function	6	8.4.1 VK.	22
3.1 Motorized valve for gas VK	6	8.4.2 VK..H	23
3.2 Motorized valve for gas VK..Z	6	9 Maintenance cycles	24
3.3 VK with closed position indicator	7	Fore more information	25
3.4 Connection diagrams	7		
3.4.1 VK with M20 cable gland	7		
3.4.2 VK with plug	7		
3.4.3 VK with closed position indicator	7		
3.4.4 VK, two-stage, with closed position indicator	8		
3.4.5 VK with two closed position indicators	8		
3.4.6 VK with 24 V holding voltage	8		
3.4.7 VK, explosion-proof version, with M20 cable gland	8		
4 Flow rate	9		
4.1 Calculating the nominal size	10		
5 Selection	11		
5.1 ProFi	11		
5.2 VK, VK..Z.	12		
5.3 VK..H.	13		
5.4 VK..X	14		
5.5 VK..HX.	15		
5.6 Type code	16		
6 Project planning information	17		
6.1 Installation	17		
6.2 Explosion protection	17		
7 Accessories	19		
7.1 Closed position indicator	19		
7.2 Switch box with holding relay	19		
8 Technical data	20		

1 Application



VK..R



VK..F

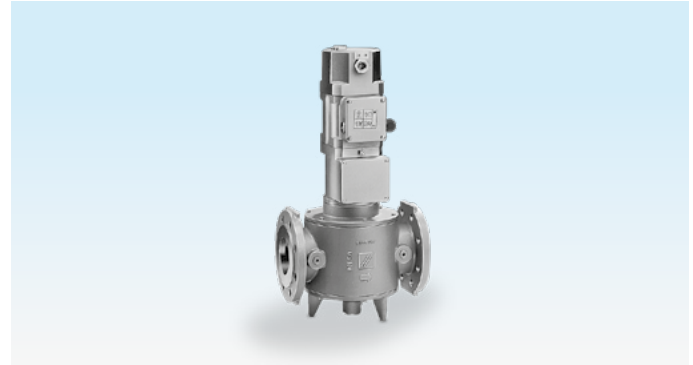

VK..X

Robust motorized valves for gas VK for safeguarding and controlling the air and gas supply to gas burners and gas appliances. For heavy-duty use in gas control and safety systems in industrial heat generation. When a closed position indicator is fitted, two-stage operation is possible.

Special device versions are suitable for Zone 1 and 2 hazardous areas or comply with the requirements pursuant to TRD 412, Para. 4.2 "Use in open-air installations" and 5.1 "Shut-off valves outside the boiler room".

1.1 Application examples



Metallurgical industry: forging furnace



Ceramics industry: intermittent shuttle kiln



Aluminium industry: shaft melting furnace

2 Certification

Certificates – see www.docuthek.com

EU certified



- 2014/35/EU (LVD), Low Voltage Directive
- 2014/30/EU (EMC), Electromagnetic Compatibility Directive
- 2014/68/EU (PED), Pressure Equipment Directive
- (EU) 2016/426 (GAR), Gas Appliances Regulation
- EN 161:2011+A3:2013

VK 40–200..X, VK 50–250..HX

- 2014/34/EU (ATEX), Explosion Protection Directives
- 2014/30/EU (EMC), Electromagnetic Compatibility Directive
- 2014/68/EU (PED), Pressure Equipment Directive
- (EU) 2016/426 (GAR), Gas Appliances Regulation
- EN 60079-0:2019
- EN 60079-6:2016
- EN 60079-7:2016
- EN 161:2013

AGA approved



Australian Gas Association, Approval No.: 3968

www.aga.asn.au/product_directory

IECEX system



Complies with the requirements of the IECEx system in conjunction with the IEC 60079 standards.

For IECEx Certificate of Conformity, see <http://iecex.iec.ch/iecex>.

Eurasian Customs Union



The products VK meet the technical specifications of the Eurasian Customs Union.

3 Function

3.1 Motorized valve for gas VK

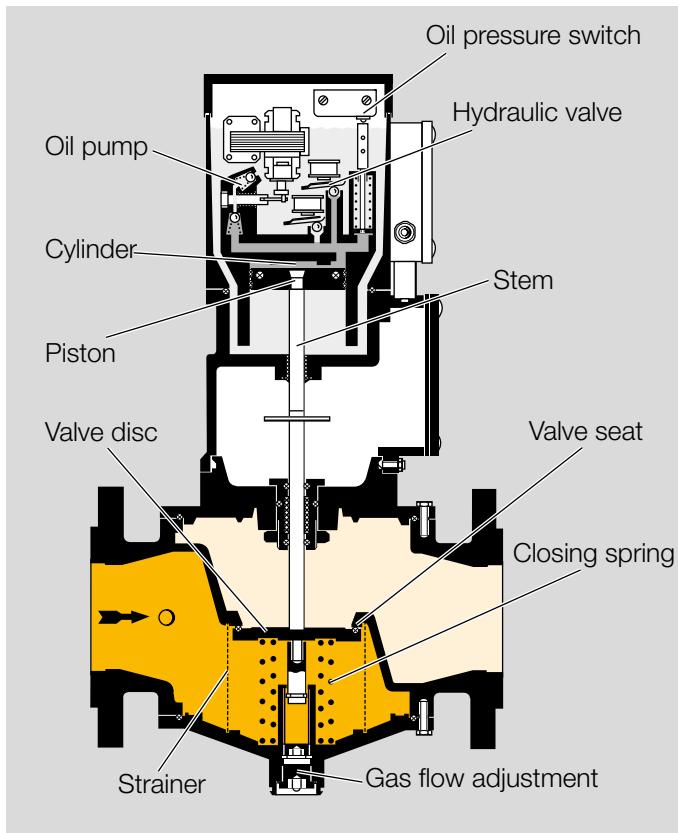

Motorized valve for gas VK is a hydraulically actuated safety valve that is closed when de-energized.

Opening: the hydraulic valve closes once mains voltage has been applied. The oil pump fills the cylinder with oil and the piston is moved down against the force of the closing spring. The valve opens. If piston, stem and valve plate are at the limit, the pressure will increase in the cylinder and the pressure switch will switch the motor off.

Closing: when the voltage is disconnected, the hydraulic valve opens and the piston is pushed up again by the force of the closing spring. The motorized valve closes within 1 second and the gas supply is stopped.

The gas volume can be set by limiting the valve stroke.

The strainer in the inlet of the motorized valve for gas prevents deposits of dirt particles on the valve seat.

3.2 Motorized valve for gas VK..Z

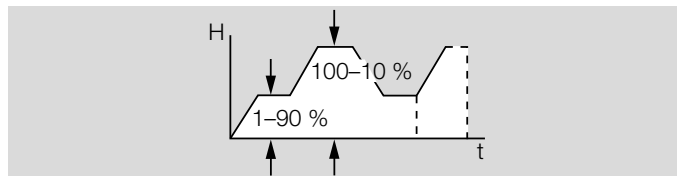

The motorized valve for gas VK..Z features a two-stage actuator. The first stage can be set between 1% and 90% using a switch. A second stage can be set between 10% and 100% using an additional flow rate restrictor.

3.3 VK with closed position indicator

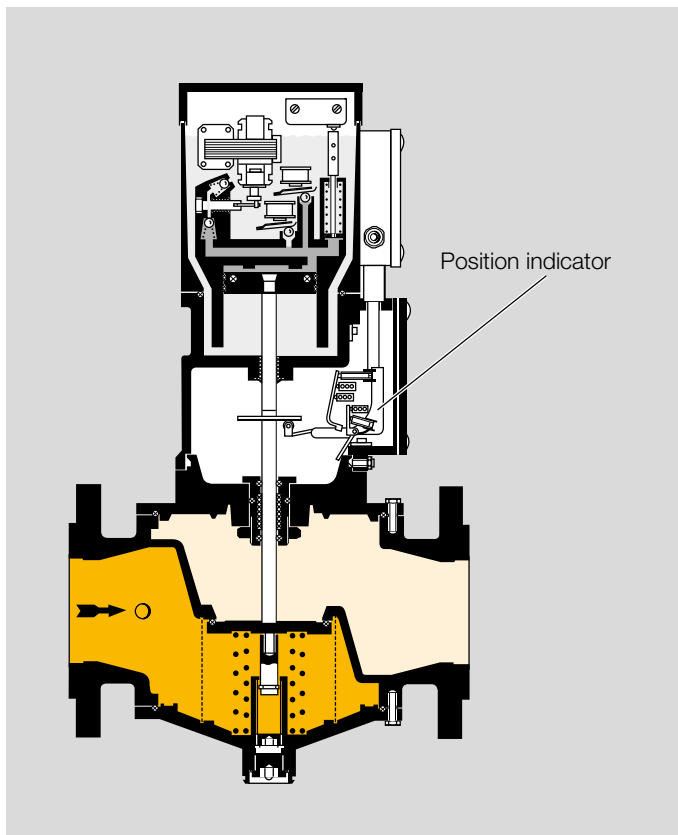

Opening: when the motorized valve for gas is opened, the closed position indicator switches and returns the “open” signal.

Closing: the motorized valve for gas VK is disconnected from the voltage supply and the closing spring presses the

valve plate on to the valve seat. In the process, the closed position indicator switches and returns the “closed” signal. Connection rating: 30–250 V, 50/60 Hz, max. 10 A (resistive load).

3.4 Connection diagrams

3.4.1 VK with M20 cable gland

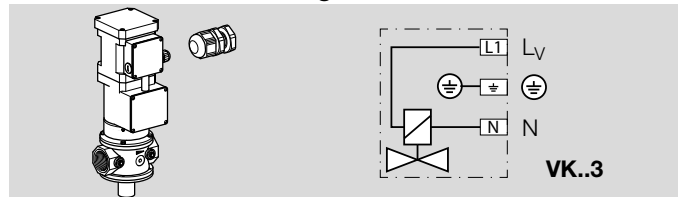

3.4.2 VK with plug

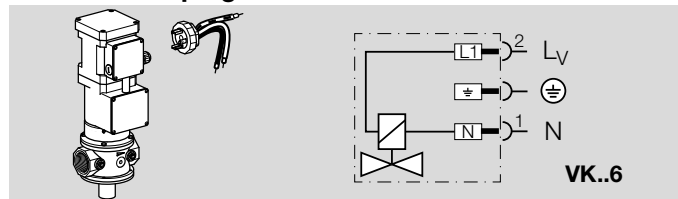

3.4.3 VK with closed position indicator

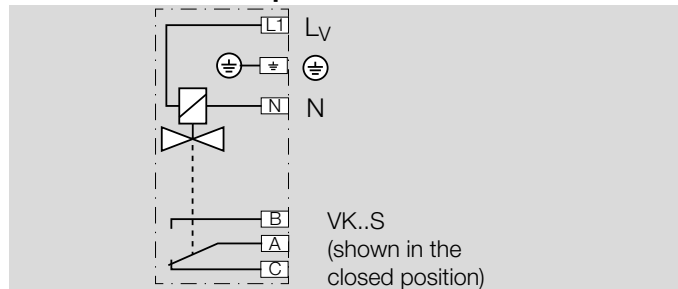

3.4.4 VK, two-stage, with closed position indicator

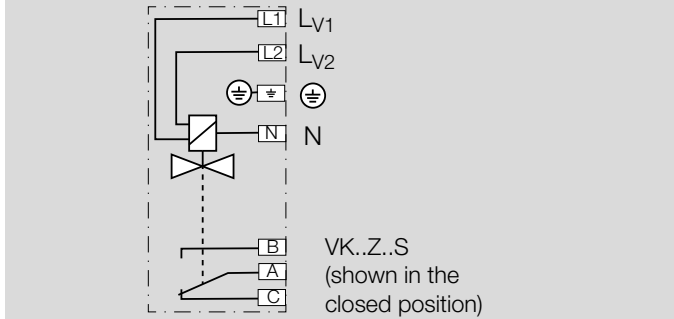

3.4.5 VK with two closed position indicators

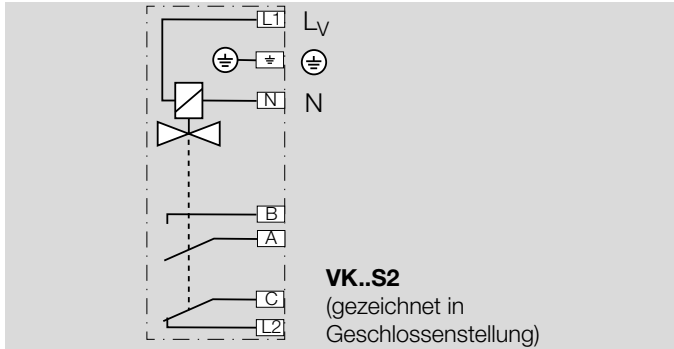

3.4.6 VK with 24 V holding voltage

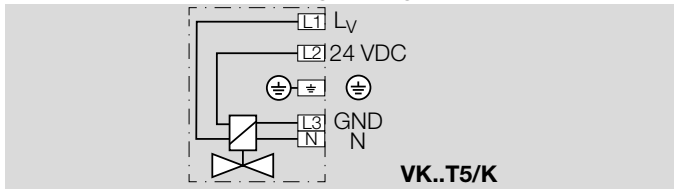

3.4.7 VK, explosion-proof version, with M20 cable gland

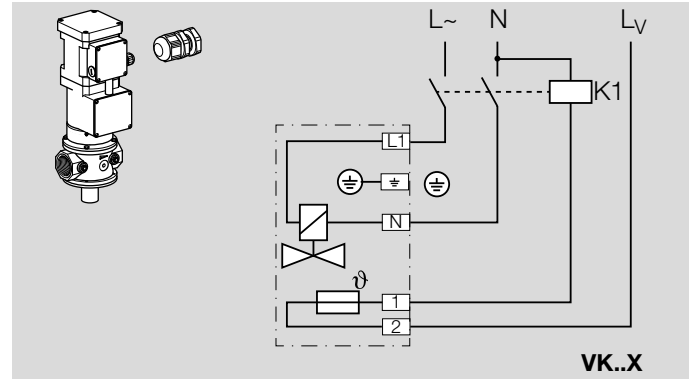

4 Flow rate

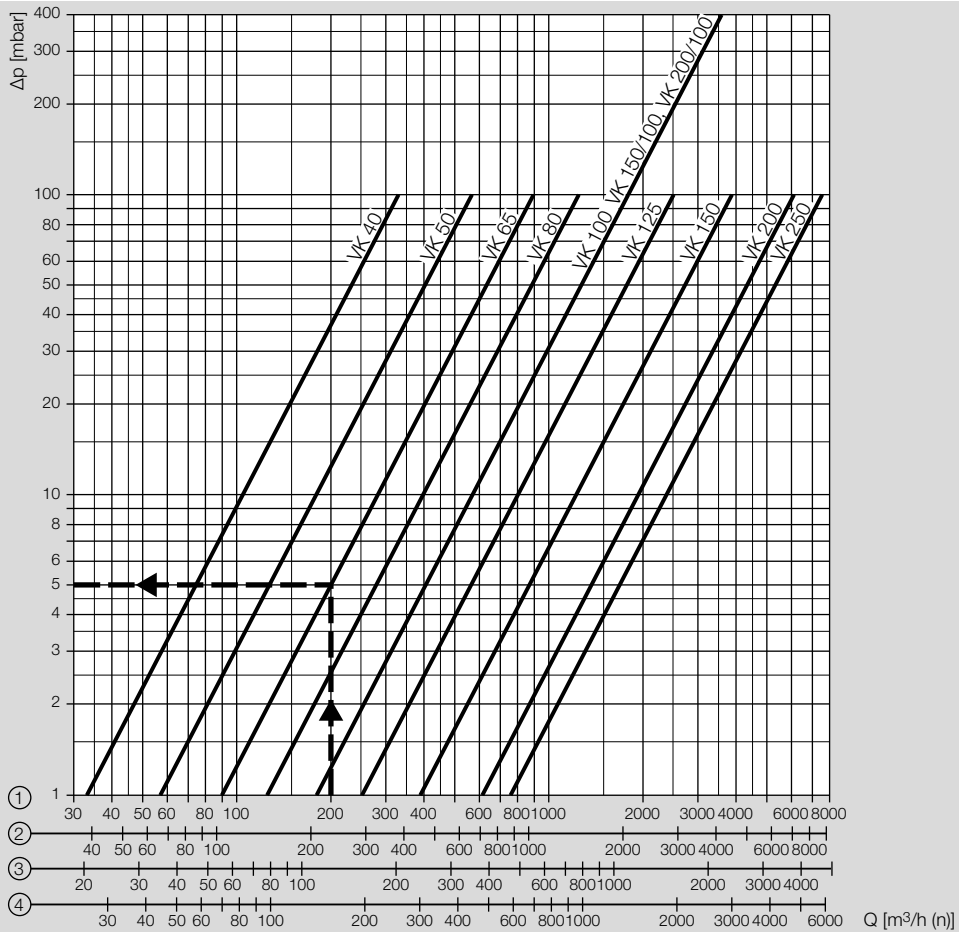

1 = natural gas ($\rho = 0.80 \text{ kg/m}^3$)

2 = town gas ($\rho = 0.58 \text{ kg/m}^3$)

3 = propane ($\rho = 2.01 \text{ kg/m}^3$)

4 = air ($\rho = 1.29 \text{ kg/m}^3$)

Reading instructions: when determining the pressure loss, operating cubic metres must be entered. Then the pressure loss Δp read must be multiplied by the absolute pressure in bar (positive pressure + 1) to account for the change in the medium's density.

Example:

inlet pressure p_u (positive pressure) = 1 bar,

gas type: natural gas,

operating flow rate $Q_b = 200 \text{ m}^3/\text{h}$,

Δp from diagram = 5 mbar,

$\Delta p = 5 \text{ mbar} \times (1 + 1) = 10 \text{ mbar}$ on the motorized valve

VK 65.

4.1 Calculating the nominal size

A web app selecting the correct product is available at www.adlatus.org.

5 Selection

5.1 ProFi

A web app selecting the correct product is available at www.adlatus.org.

5.2 VK, VK..Z

Option	VK 40	VK 50	VK 65	VK 80	VK 100	VK 125	VK 150	VK 200
Pipe connection	R, F	R, F	R, F	F	F	F	F	F
Inlet pressure	10, 40	40, 40	10, 31	10, 24	10	06	04	02
2-stage ¹⁾	Z	Z	Z	Z	Z	Z	Z	Z
Mains voltage	T5, W5, W6, Y, Q6, M, P, T5/K	T5, W5, W6, Y, Q6, M, P, T5/K	T5, W5, W6, Y, Q6, M, P, T5/K	T5, W5, W6, Y, Q6, M, P, T5/K	T5, W5, W6, Y, Q6, M, P, T5/K	T5, W5, W6, Y, Q6, M, P, T5/K	T5, W5, W6, Y, Q6, M, P, T5/K	T5, W5, W6, Y, Q6, M, P, T5/K
Valve housing ²⁾	A	A, G	A, G	A, G	A, G	A, G	A, G	A, G
Electrical connection	9, 6	9, 6	9, 6	9, 6	9, 6	9, 6	9, 6	9, 6
Pressure measuring point	3	3	3	3	3	3	3	3
Flow adjustment	D	D	D	D	D	–	–	–
Closed position indicator ¹⁾	S, S2	S, S2	S, S2	S, S2	S, S2	S, S2	S, S2	S, S2
Viton	V	V	V	V	V	V	V	–
Viewing window	F	F	F	F	F	F	F	F

¹⁾ The VK..Z is always supplied with a closed position indicator.

²⁾ The higher inlet pressure is applicable for VK..G. It is only available with a flanged connection.

Order example

VK 65R10T5A93D

5.3 VK..H

Option	VK 50	VK 65	VK 80	VK 100	VK 125	VK 150	VK 150/100	VK 200	VK 200/100	VK 250
Pipe connection	F	F	F	F	F	F	F	F	F	F
Inlet pressure	80	80	60	40	10, 20	10, 15	40	10	40	05
Mains voltage	T5, W5, W6, Y, Q6, M, P, T5/K	T5, W5, W6, Y, Q6, M, P, T5/K	T5, W5, W6, Y, Q6, M, P, T5/K	T5, W5, W6, Y, Q6, M, P, T5/K	T5, W5, W6, Y, Q6, M, P, T5/K	T5, W5, W6, Y, Q6, M, P, T5/K	T5, W5, W6, Y, Q6, M, P, T5/K	T5, W5, W6, Y, Q6, M, P, T5/K	T5, W5, W6, Y, Q6, M, P, T5/K	T5, W5, W6, Y, Q6, M, P, T5/K
Higher inlet pressure	H	H	H	H	H	H	H	H	H	H
Valve housing	G	G	G	G	A ¹⁾ , G	A ¹⁾ , G	G	A, G	G	A
Electrical connection	9, 6	9, 6	9, 6	9, 6	9, 6	9, 6	9, 6	9, 6	9, 6	9, 6
Pressure measuring point	3	3	3	3	3	3	3	3	3	3
Flow adjustment	D	D	D	D	–	–	–	–	–	–
Closed position indicator	S, S2	S, S2	S, S2	S, S2	S, S2	S, S2	S, S2	S, S2	S, S2	S, S2
Viton	V	V	V	V	V	V	–	V	–	–
Viewing window	F	F	F	F	F	F	F	F	F	F

¹⁾ For 1 bar: AISi = standard

Order example

VK 80F60T5HG93D

5.4 VK..X

Option	VK 40	VK 50	VK 65	VK 80	VK 100	VK 125	VK 150	VK 200
Pipe connection	R, F	R, F	R, F	F	F	F	F	F
Inlet pressure	10, 40	40, 40	10, 31	10, 24	10	06	04	02
Mains voltage	W5, W6, M	W5, W6, M	W5, W6, M	W5, W6, M	W5, W6, M	W5, W6, M	W5, W6, M	W5, W6, M
Explosion-proof	X	X	X	X	X	X	X	X
Valve housing ¹⁾	A	A, G	A, G	A, G	A, G	A, G	A, G	A, G
Electrical connection	4	4	4	4	4	4	4	4
Pressure measuring point	3	3	3	3	3	3	3	3
Flow adjustment	D	D	D	D	D	–	–	–
Viton	V	V	V	V	V	V	V	–

¹⁾ The higher inlet pressure is applicable for VK..G. It is only available with a flanged connection.

Order example

VK 65F10W5A43D

5.5 VK..HX

Option	VK 50	VK 65	VK 80	VK 100	VK 125	VK 150	VK 150/100	VK 200	VK 200/100	VK 250
Pipe connection	F	F	F	F	F	F	F	F	F	F
Inlet pressure	80	80	60	40	10, 20	10, 15	40	10	40	05
Mains voltage	W5, W6, M	W5, W6, M	W5, W6, M	W5, W6, M	W5, W6, M	W5, W6, M	W5, W6, M	W5, W6, M	W5, W6, M	W5, W6, M
Higher inlet pressure	H	H	H	H	H	H	H	H	H	H
Explosion-proof	X	X	X	X	X	X	X	X	X	X
Valve housing	G	G	G	G	A ¹⁾ , G	A ¹⁾ , G	G	A, G	G	A
Electrical connection	4	4	4	4	4	4	4	4	4	4
Pressure measuring point	3	3	3	3	3	3	3	3	3	3
Flow adjustment	D	D	D	D	-	-	-	-	-	-
Viton	V	V	V	V	V	V	-	V	-	-

¹⁾ For 1 bar: AISi = standard

Order example

VK 80F60W5HXG43D

5.6 Type code

VK	Motorized valve for gas
40-250	Nominal size
R	Rp internal thread
F	Flange to ISO 7005
02	p_u max. 230 mbar
04	p_u max. 400 mbar
05	p_u max. 500 mbar
06	p_u max. 600 mbar
10	p_u max. 1 bar
15	p_u max. 1.5 bar
20	p_u max. 2 bar
24	p_u max. 2.4 bar
31	p_u max. 3.1 bar
40	p_u max. 4 bar
60	p_u max. 6 bar
80	p_u max. 8 bar
Z	2-stage
T5	Mains voltage 220/240 V AC, 50 Hz
T5/K	Mains voltage 220 V AC, 50 Hz / 24 V DC
W5	Mains voltage 230 V AC, 50 Hz
Q6	Mains voltage 120 V AC, 60 Hz
W6	Mains voltage 230 V AC, 60 Hz
M	Mains voltage 110 V AC, 50/60 Hz
X	Explosion-proof version, IP 65
H	For higher inlet pressures
A	Valve housing made of AISi

G	Valve housing made of GGG 50 complying with TRD 412 and GUV
4	Terminal connection box, IP 65
6	Connection box with 4-pin standard socket, IP 54
6L	Connection box with 4-pin standard socket, with lamp, IP 54
9	Metal terminal connection box, IP 54
3	Screw plugs at the inlet and outlet
D	With flow adjustment
S	With closed position switch
V	With Viton valve disc seal
F	With viewing window

6 Project planning information

6.1 Installation

VK, VK..H

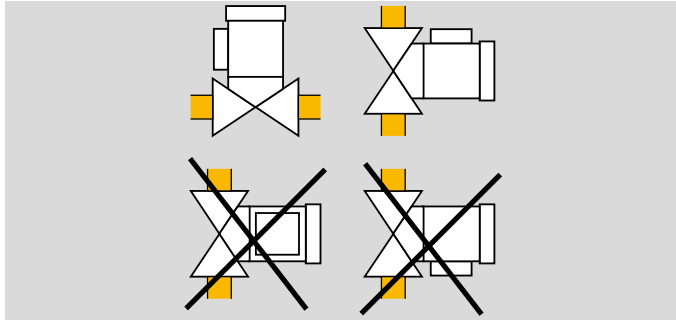

Installation position: actuator in the vertical upright position or tilted up to the horizontal, not upside down. The connection box must point upwards.

VK..X, VK..HX

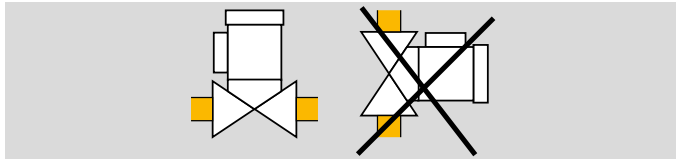

Installation position: actuator in the vertical upright position only.

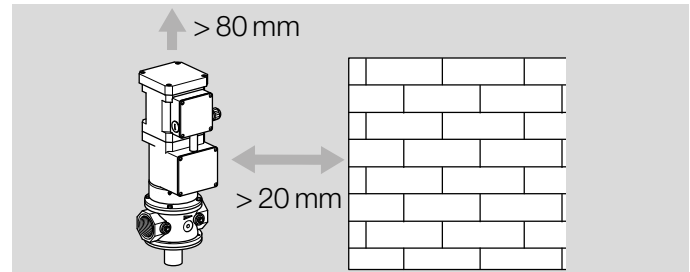

The motorized valve for gas VK must not be in contact with masonry. Minimum clearance to the side: 20 mm.

Ensure that there is sufficient space for installation and adjustment. Minimum clearance to the top: 80 mm.

Do not store or install the unit in the open air.

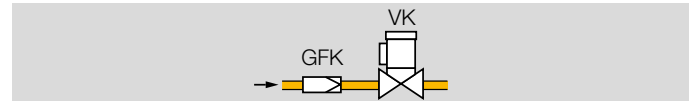

Sealing material and dirt, e.g. thread cuttings, must not be allowed to get into the valve housing.

Install a filter (GFK) upstream of every system.

6.2 Explosion protection

Motorized valves for gas VK..X and VK..HX can be installed in Zone 1 and 2 hazardous areas. Only design-approved electrical operating equipment may be used for this.



Marking pursuant to ATEX:

⊕ II 2G Ex eb ob IIC T5 Gb

Marking pursuant to IECEx:

Ex eb ob IIC T5 Gb

Legend

 II 2G Ex eb ob IIC T5 Gb	
	Specific marking of explosion protection
II	Equipment group for general industries, all flammable gases and vapours (as defined by Directive 2014/34/EU)
2G	Equipment category for explosive gases, vapours and hazes
Ex	Symbol for electrical equipment built according to European standards
eb	Type of ignition protection: increased safety
ob	Type of ignition protection: oil immersion
IIC	Suitable for gases of explosion group IIC; field of application: electrical equipment for all hazardous areas except for mines susceptible to firedamp
T5	Maximum surface temperature of the device determined: 100°C
Gb	Equipment protection level (EPL); device with high level of protection for use in potentially explosive atmospheres, in which there is no danger of ignition in normal operation or in the case of foreseeable faults/malfunctions

7 Accessories

7.1 Closed position indicator



For the “closed” or “not closed” signal.

Type	Order No.
VK..S	74911637
VK..S2	74960023
VK..HS	74918705
VK..HS2	74919317

7.2 Switch box with holding relay

For “manual restart”, a separate switch box with holding relay can be connected. The holding relay prevents the gas from being automatically released in the case of a power failure.

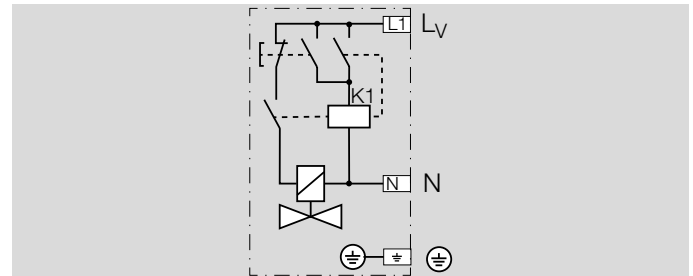

Two different voltage variants are available:

220/240 V switch box: SK HR-T, Order No. 84408017,
110/120 V switch box: SK HR-N, Order No. 84408018.

8 Technical data

8.1 Ambient conditions

Icing, condensation and dew in and on the unit are not permitted.

Avoid direct sunlight or radiation from red-hot surfaces on the unit.

Note the maximum medium and ambient temperatures!

Avoid corrosive influences, e.g. salty ambient air or SO_2 .

The unit may only be stored/installed in enclosed rooms/buildings.

The unit is suitable for a maximum installation height of 2000 m AMSL.

Ambient temperature:

VK., VK..H, VK..Z: -15°C to $+60^\circ\text{C}$,

VK..X, VK..HX: -15°C to $+40^\circ\text{C}$.

Long-term use in the upper ambient temperature range accelerates the ageing of the elastomer materials and reduces the service life (please contact manufacturer).

Storage and transport temperature: -20°C to $+40^\circ\text{C}$.

Enclosure: IP 54,
safety class 1.

This unit is not suitable for cleaning with a high-pressure cleaner and/or cleaning products.

8.2 Mechanical data

Gas types: natural gas, town gas, LPG (gaseous), biogas (max. 0.1 %-by-vol. H 2S), landfill gas or clean air; other gases on request.

The gas must be dry in all temperature conditions and must not contain condensate.

Opening time:

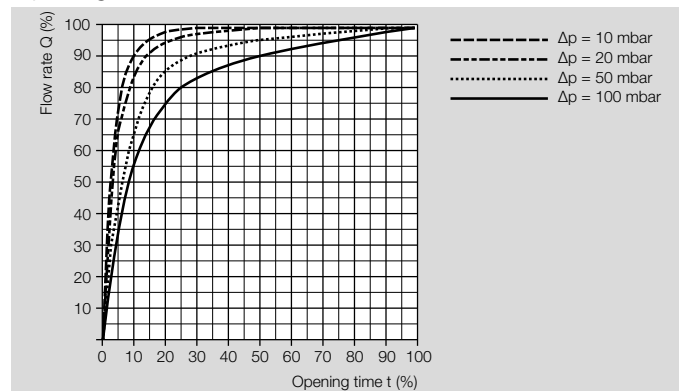

Nominal size	Opening time t VK	Opening time t VK..H
DN 40	5 s	—
DN 50–65	8 s	12 s
DN 80–100	10 s	18 s
DN 125–200	13 s	24 s
DN 250	—	24 s

Closing time: $< 1 \text{ s}$.

Safety valve: Class A, Group 2 pursuant to EN 161.

Duty cycle: 100%.

Valve housing: aluminium, GGG 40 (coated inside and outside with epoxy powder coating).

Valve plate: Perbunan, Viton.

Motor actuator: AISi.

Internal thread: Rp to ISO 7-1.

Flange: ISO 7005, PN 16.

Medium temperature = ambient temperature.

8.3 Electrical data

Mains voltage:

220/240 V AC, +10/-15%, 50 Hz (standard),

230 V AC+10/-15%, 50 Hz,

230 V AC, +10/-15%, 60 Hz,

220 V AC, +10/-15%, 50 Hz, 24 V DC,

200 V AC, +10/-10%, 50/60 Hz,

120 V AC, +10/-15%, 60 Hz,

110 V AC, +10/-15%, 50/60 Hz,

100 V AC, +10/-5%, 50/60 Hz.

Power consumption:

when opening: 90 VA, 50 W, open: 9 VA, 9 W.

Electrical connection:

– plug with socket to EN 175301-803,

– cable gland: M20,

– connection terminal: 2.5 mm².

8.4 Dimensions

8.4.1 VK

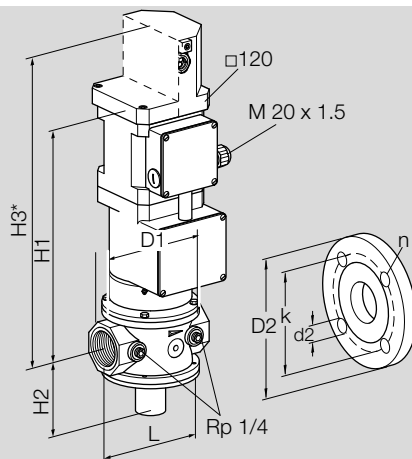

Type	Conne- ction		Dimensions									p _u max.		Q	Weight*	
			L	H1	H2	H3	D1	D2	k	d2	n	AlSi	GGG	Δp = 1 mbar	Al	GGG
	DN	Rp	mm	mm	mm	mm	mm	mm	mm	mm	mm	mbar	mbar	m ³ /h air	kg	kg
VK 40	–	Rp 1½	150	345	100	430	127	–	–	–	–	1000/4000	–	27.5	8	–
VK 40	40	–	200	345	100	430	127	150	110	18	4	1000/4000	–	27.5	9	–
VK 50	–	Rp 2	180	350	117	435	155	–	–	–	–	1000/4000	–	45.0	9	–
VK 50	50	–	230	350	117	435	155	165	125	18	4	1000/4000	4000	45.0	11	20.5
VK 65	–	Rp 2½	218	370	135	455	182	–	–	–	–	1000/3100	–	70.0	11	–
VK 65	65	–	290	370	135	455	182	185	145	18	4	1000/3100	3100	70.0	13	26
VK 80	80	–	310	378	137	463	210	200	160	18	8	1000/2400	2400	103.0	15	32
VK 100	100	–	350	400	163	485	248	229	180	18	8	1000	1000	148.0	19	41.5
VK 125	125	–	400	450	158	535	314	250	210	18	8	600	600	206.0	24	60
VK 150	150	–	480	445	173	530	344	285	240	23	8	400	400	310.0	32	80
VK 200	200	–	600	475	218	560	420	340	295	23	12	230	230	490.0	52	141

* VK..X: + 1.5 kg

8.4.2 VK..H

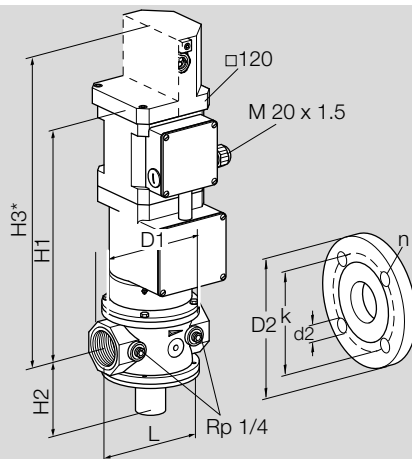

Type	Dimensions										Drilling		p _u max., Class A		Q	Weight*	
	Conne- ction DN	L	H1	H2	H3	D1	D2	k	d2	n	AlSi	GGG	Δp = 1 mbar m ³ /h air	Al	GGG		
		mm	mm	mm	mm	mm	mm	mm	mm	mm		mbar		mbar	kg	kg	
VK 50..H	50	230	414	117	499	155	165	125	18	4	–	8000	45.0	–	21		
VK 65..H	65	290	434	135	519	182	185	145	18	4	–	8000	70.0	–	27		
VK 80..H	80	310	442	137	527	210	200	160	18	8	–	6000	103.0	–	33		
VK 100..H	100	350	464	163	549	248	220	180	18	8	–	4000	148.0	–	43		
VK 125..H	125	400	514	158	599	314	250	210	18	8	1000	2000	206.0	25	61		
VK 150..H	150	480	509	173	594	344	285	240	23	8	1000	1500	310.0	33	81		
VK 150/100..H	150	480	509	173	–	344	285	240	23	8	–	4000	148.0	–	81		
VK 200..H	200	600	539	218	624	420	340	295	23	12	1000	1000	490.0	53	142		
VK 200/100..H	200	600	539	218	–	420	340	295	23	12	–	4000	148.0	–	142		
VK 250..H	250	730	573	270	658	496	405	355	27	12	500	–	590.0	80	–		

* VK..X: + 1.5 kg

9 Maintenance cycles

At least once a year, at least twice a year in the case of biologically produced methane.

Fore more information

The Honeywell Thermal Solutions family of products includes Honeywell Combustion Safety, Eclipse, Exothermics, Hauck, Kromschroder and Maxon. To learn more about our products, visit ThermalSolutions.honeywell.com or contact your Honeywell Sales Engineer.

Elster GmbH
Strothweg 1, D-49504 Lotte
T +49 541 1214-0
hts.lotte@honeywell.com
www.kromschroeder.com

© 2020 Elster GmbH

We reserve the right to make technical modifications in the interests of progress.

