

# *Eclipse AirHeat Burners*

---

*Model AH*

*Technical Information*

*Version 2*

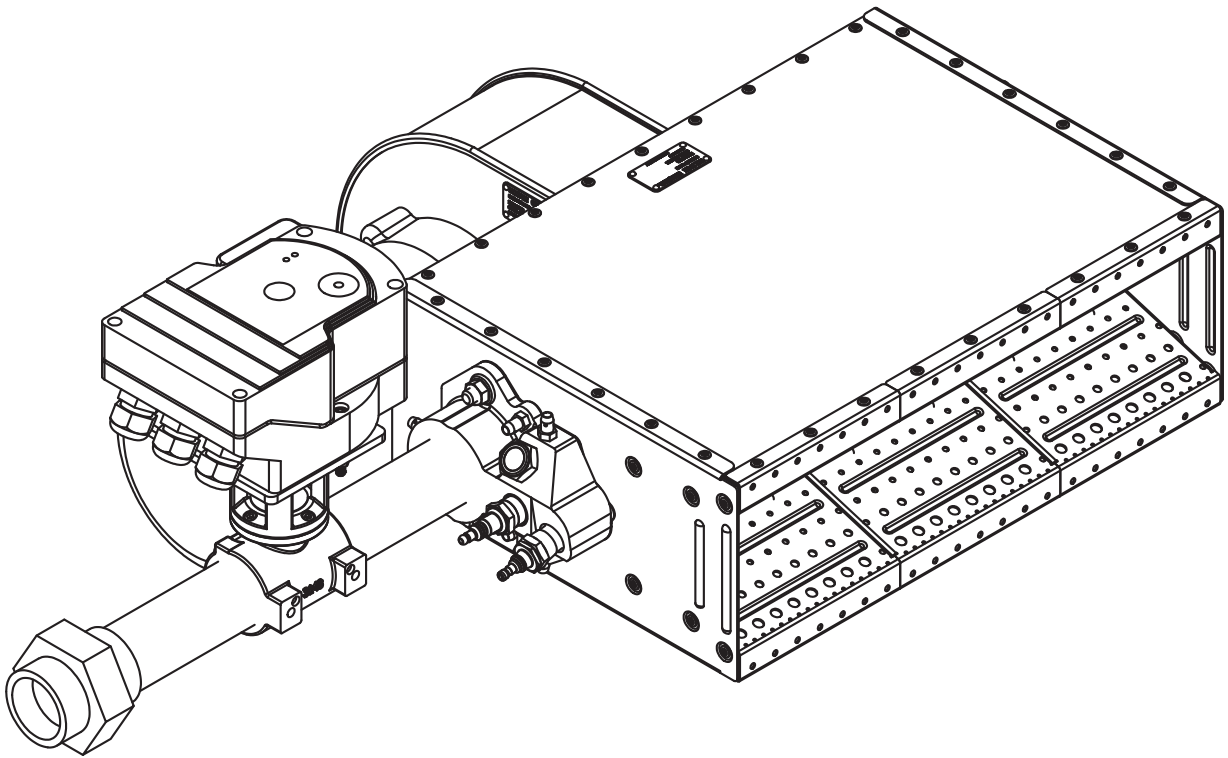

## **Copyright**

Copyright 2017 by Eclipse, Inc. All rights reserved worldwide. This publication is protected by federal regulation and shall not be copied, distributed, transmitted, transcribed or translated into any human or computer language, in any form or by any means, to any third parties, without the express written consent of Eclipse, Inc.

## **Disclaimer Notice**

In accordance with the manufacture's policy of continual product improvement, the product presented in this brochure is subject to change without notice or obligation.

The material in this manual is believed adequate for the intended use of the product. If the product is used for purposes other than those specified herein, confirmation of validity and suitability must be obtained. Eclipse warrants that the product itself does not infringe upon any United States patents. No further warranty is expressed or implied.

## **Liability & Warranty**

We have made every effort to make this manual as accurate and complete as possible. Should you find errors or omissions, please bring them to our attention so that we may correct them. In this way we hope to improve our product documentation for the benefit of our customers. Please send your corrections and comments to our Marketing Communications Manager.

It must be understood that Eclipse's liability for its product, whether due to breach of warranty, negligence, strict liability, or otherwise is limited to the furnishing of replacement parts and Eclipse will not be liable for any other injury, loss, damage or expenses, whether direct or

consequential, including but not limited to loss of use, income, or damage to material arising in connection with the sale, installation, use of, inability to use, or the repair or replacement of Eclipse's products.

Any operation expressly prohibited in this manual, any adjustment, or assembly procedures not recommended or authorized in these instructions shall void the warranty.

## **Document Conventions**

There are several special symbols in this document. You must know their meaning and importance.

The explanation of these symbols follows below. Please read it thoroughly.

## **How To Get Help**

If you need help, contact your local Eclipse representative. You can also contact Eclipse at:

1665 Elmwood Rd.  
Rockford, Illinois 61103 U.S.A.  
Phone: 815-877-3031  
Fax: 815-877-3336  
<http://www.eclipsenet.com>

Please be sure to know your equipment's information found on the product label when contacting the factory so we may better serve you.



This is the safety alert symbol. It is used to alert you to potential personal injunt hazards. Obey all safety messages that follow this symbol to avoid possible injury or death.



Indicates a hazardous situation which, if not avoided, will result in death or serious injury.



Indicates a hazardous situation which, if not avoided, could result in death or serious injury.



Indicates a hazardous situation which, if not avoided, could result in minor or moderate injury.

**NOTICE**

Is used to address practices not related to personal injury.

**NOTE**

Indicates an important part of text. Read thoroughly.

---

# Table of Contents

<b>1 Introduction</b> .....	<b>4</b>
Product Description .....	4
Audience.....	4
Purpose .....	4
Related Documents .....	4
<b>2 Safety</b> .....	<b>5</b>
Safety Warnings .....	5
Capabilities .....	5
Operator Training .....	5
Replacement Parts .....	5
<b>3 System Design</b> .....	<b>6</b>
Design .....	6
Step 1: Burner Option Selection .....	6
Step 2: Blower Option Selection.....	7
Step 3: Control Methodology .....	8
Step 4: Ignition System.....	9
Step 5: Flame Monitoring Control System.....	9
Step 6: Main Gas Shut-Off Valve Train .....	10
<b>Appendix</b> .....	<b>i</b>
Conversion Factors .....	i
Key to Schematics.....	ii

# Introduction

1

## Product Description

Eclipse AirHeat Burners are line type burners ideal for generating large volumes of clean, hot air. Applications include ovens, dryers, fume incinerators, and similar industrial equipment. Burners are constructed of aluminum burner bodies and diverging stainless steel air wings. The burner bodies supply fuel to the center of the air wings. The air and fuel mixture inside the burner is controlled to optimize emissions and efficiency.

AirHeat Burners are assembled from straight and tee sections allowing for customized inputs. An integral combustion air blower can be ordered mounted on the back of the burner's steel or stainless steel housing case. By supplying the correct air volume and pressure to the burner, the blower allows stable operation over a wide range of duct velocities without installing a profile plate around the burner.

Brackets are available for slot firing or duct mounting and flanges are available for continuous flange mounting. Right hand or left hand gas piping can be supplied with BSP or NPT connections. A reduced port fuel control valve can be supplied with a variety of control motor and linkage options. Ignition can be by direct spark or by spark ignited pilot. Flame rod flame supervision can be from either or both ends. Several air flow switches are also available factory mounted on the burner.

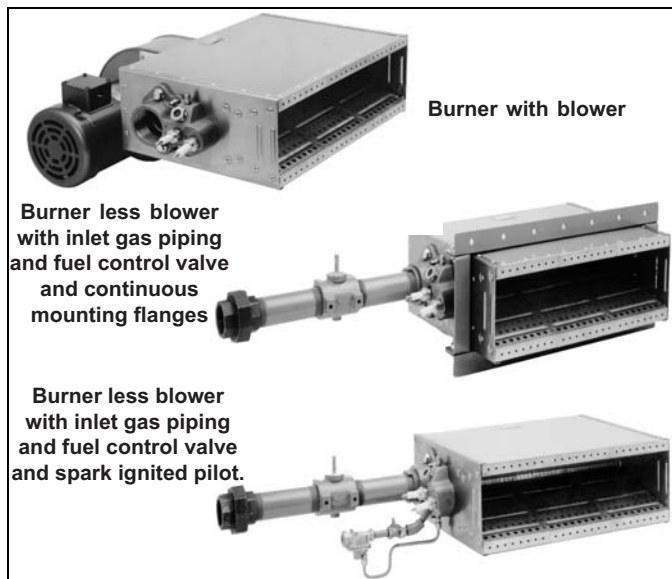

Figure 1.1. AirHeat Burner

## Audience

This manual has been written for personnel already familiar with all aspects of a gas burner and its add-on components, also referred to as the burner package.

These aspects are:

- Design / Selection
- Use
- Maintenance
- Safety

The audience is expected to be qualified and have experience with this type of equipment and its working environment.

## Purpose

The purpose of this manual is to make sure that the design of a safe, effective and trouble-free system is carried out.

## AirHeat Documents

### **Design Guide No. 135**

- This document

### **Datasheet Series No. 135**

- Available for individual AirHeat models
- Required to complete installation

### **Installation Guide No. 135**

- Used with Datasheet to complete installation

## Related Documents

- EFE 825 (Combustion Engineering Guide)
- Eclipse Bulletins and Information Guides: 710, 720, 732, 742, 760, 818, 832, 852, 854, 856, 610, 620, 630, 826, 820, 930, I-354

Important notices which help provide safe burner operation will be found in this section. To avoid personal injury and damage to the property or facility, the following warnings must be observed. All involved personnel should read this entire manual carefully before attempting to start or operate this system. If any part of the information in this manual is not understood, contact Eclipse before continuing.

## Safety Warnings



### **DANGER**

- **The burners covered in this manual are designed to mix fuel with air and burn the resulting mixture. All fuel burning devices are capable of producing fires and explosions when improperly applied, installed, adjusted, controlled or maintained.**
- **Do not bypass any safety feature; fire or explosion could result.**
- **Never try to light the burner if it shows signs of damage or malfunction.**



### **WARNING**

- **The burner is likely to have HOT surfaces. Always wear protective clothing when approaching the burner.**
- **Eclipse products are designed to minimize the use of materials that contain crystalline silica. Examples of these chemicals are: respirable crystalline silica from bricks, cement or other masonry products and respirable refractory ceramic fibers from insulating blankets, boards, or gaskets. Despite these efforts, dust created by sanding, sawing, grinding, cutting and other construction activities could release crystalline silica. Crystalline silica is known to cause cancer, and health risks from the exposure to these chemicals vary depending on the frequency and length of exposure to these chemicals. To reduce the risk, limit exposure to these chemicals, work in a well-ventilated area and wear approved personal protective safety equipment for these chemicals.**

### **NOTICE**

- **This manual gives information for the use of these burners for their specific design purpose. Do not deviate from any instructions or application limits in this manual without written advice from Eclipse.**

## Capabilities

Only qualified personnel, with good mechanical aptitude and experience with combustion equipment, should adjust, maintain, or troubleshoot any mechanical or electrical part of this system.

## Operator Training

The best safety precaution is an alert and trained operator. Train new operators thoroughly and have them demonstrate an adequate understanding of the equipment and its operation. A regular retraining schedule should be administered to ensure operators maintain a high degree of proficiency.

## Replacement Parts

Order replacement parts from Eclipse only. Any customer-supplied valves or switches should carry UL, FM, CSA, CGA and/or CE approval where applicable.

# System Design

# 3

## Design

When selecting an AirHeat burner, choices are available to define a burner that will be safe and reliable for the system in which it will be installed. The design process is divided into the following steps:

1. Burner Option Selection:
  - Burner Model / Size Selection
  - Burner Style (single or multiple rows)
  - Air Supply
  - Fuel Type
  - Manifold Type
  - Mounting Flange
  - Burner Configuration
  - Gas Pipe Connection
  - Control Valve
  - Ignition Type
  - Flame Supervision
  - Control Motor
  - Air Flow Switch
2. Blower Option Selection:
  - Power Supply Frequency
  - Blower Motor Type
  - Blower Inlet
  - Motor Orientation
  - Remote Blower Sizing
3. Control Methodology:
  - Burner Control
4. Ignition System:
  - Ignition Transformer
  - Trial for Ignition
  - Ignition Gas Piping
5. Flame Monitoring System:
  - Flame Sensor
  - Flame Monitoring Control
6. Main Gas Shut-Off Valve Train Selection:
  - Component Selection
  - Valve Train Size

## Step 1: Burner Option Selection

This section describes how to select burner options to suit an application. Use the AirHeat Price List 135 and Datasheet, 135 when following this selection process.



### CAUTION

- **Consult EFE-825, Eclipse Combustion Engineering Guide, or contact Eclipse Combustion if you have special conditions or questions.**

## **Burner Model / Size Selection**

Consider the following when selecting the burner size:

- **Heat Input** - Calculate the required heat input to achieve the required heat balance.
- **Process Air Temperature** - Upstream process air temperature will determine the housing material required.
- **Combustion Chamber Pressure** - Consider the effects that large or varying chamber pressures have on burner performance.
- **Altitude** - Data supplied is based on burner operation at sea level.
- **Combustion Air Supply** - Combustion air should be fresh (20.9% O<sub>2</sub>) and clean (without corrosives).
- **Combustion Air Temperature** - Changes in air supply temperature can affect the burner performance. The combustion air supply temperature should not exceed 250° F.
- **Fuel Type** - Variation in calorific value and density will affect burner performance.

## **Burner Style**

Standard AirHeat burners are available in straight sections only. Tee sections are available as engineered solutions. The standard housing material is steel, but for upstream process temperature above 500°F (260°C), the stainless steel housing option should be chosen.

## **Air Supply**

AirHeat burners can be ordered with or without a combustion air blower directly mounted to the burner. For remote blower applications, see “Remote Blower Sizing”.

## Fuel Type

Fuel	Symbol	Gross Heating Value	Specific Gravity	WOBBE Index
Natural Gas	CH <sub>4</sub> 90%+	1000 BTU/ft <sup>3</sup> (40.1 MJ/m <sup>3</sup> )	0.60	1290 BTU/ft <sup>3</sup>
Propane	C <sub>3</sub> H <sub>8</sub>	2525 BTU/ft <sup>3</sup> (101.2 MJ/m <sup>3</sup> )	1.55	2028 BTU/ft <sup>3</sup>
Butane	C <sub>4</sub> H <sub>10</sub>	3330 BTU/ft <sup>3</sup> (133.7 MJ/m <sup>3</sup> )	2.09	2303 BTU/ft <sup>3</sup>

BTU/ft<sup>3</sup> @ standard conditions (MJ/m<sup>3</sup> @ normal conditions)

If using an alternative fuel supply, contact Eclipse with an accurate breakdown of the fuel components.

## Manifold Type

AirHeat burners are available with aluminum burner manifolds only.

## Mounting Flange

Select the mounting hardware best suited to your application. Hardware is available for Duct Mounting, Slot Firing and Continuous Flange Mounting.

## Burner Configuration

Left hand or right hand piping is available. Configuration is based on viewing the burner from the air inlet.

## Gas Pipe Connection

The piping, burner gas inlet, and fuel modulating valve (if selected) are threaded using the customer selected pipe thread option.

## Control Valve

AirHeat Burners can be supplied with the following control options:

- **Reduced Port Packaged** - The control valve is sized based on burner input and fuel type. (See pages 3 & 4 of Datasheet 135)
- **Reduced Port Separate** - Order when fuel control valve cannot be mounted directly to the burner due to system considerations.
- **Less Control Valve** - If not supplied by Eclipse, customer must supply a suitable fuel control valve capable of supplying fuel in accordance with the burners operating range.

## Ignition Type

Ignition can be by direct spark or spark ignited pilot.

Direct spark ignition can be used on burners up to 3.0 ft (1 m) long and up to 60% capacity.

Do not use 1/2 wave ignition transformers. Use 6kVAC transformers.

## Flame Supervision

Flame supervision is by flame rod or UV scanner. When using UV scanners, Eclipse recommends a flame monitoring system that terminates the ignition spark at the end of the trial for ignition period not when it "sees" flame. Eclipse recommends that flame supervision is fitted at both ends of the burner when the flame travels more than 10 ft.

## Control Motor

Select a control motor. Standard control motor options include various models which Eclipse will mount to the burner. Burners can be ordered with control motor bracket and mounting hardware only. Customer supplied control motors must conform to the these specifications:

- rotation not to exceed 2 rpm
- minimum torque of 25 in-lb. (2,8 Nm)
- 90° stroke
- continuous modulating or high/low modulating control
- reversible direction of rotation
- certain applications may require control motors with a limit switch or switches if:
  - the burner capacity is to be limited to fit an application
  - there is a need to indicate a high and/or low fire butterfly valve position

## Air Flow Switch

The air flow switch provides a signal to the monitoring system when there is not enough air pressure from the blower. If a switch is selected, it will be factory mounted.



- **Eclipse supports the NFPA regulation requiring, as a minimum standard for main gas shut-off systems, the use of an air pressure switch in conjunction with other system components.**

## Step 2: Blower Option Selection

**NOTE:** Standard blower options are listed in Price List 135, additional blower options are available through Eclipse, price and lead-time may vary.

## Power Supply Frequency

Blowers are available with 60Hz motors. Motors have NEMA frames.

## Blower Motor Type

Motor types include various options: voltages, single or three phase.

## Blower Inlet

When selecting an inlet, consider the following:

- amount and size of particles in the air
- cleanliness requirements of the process

## Motor Orientation

All AirHeat burners are assembled with a right-hand blower motor orientation.

## Remote Blower Sizing

For remote blower applications, the blower should be sized to supply sufficient flow and pressure to the burner to ensure proper burner performance.

### Example:

Fire an AirHeat0200 burner on natural gas at 800,000 BTU/hr/ lineal ft. resulting in maximum input of 1,600,000 BTU/hr at an air pressure drop of 1" w.c. In the chart, locate 800,000 Btu/hr/LF and read up to the 1" w.c.  $\Delta P$  curve and then left to determine the excess air percentage. In this case, 44% excess air.

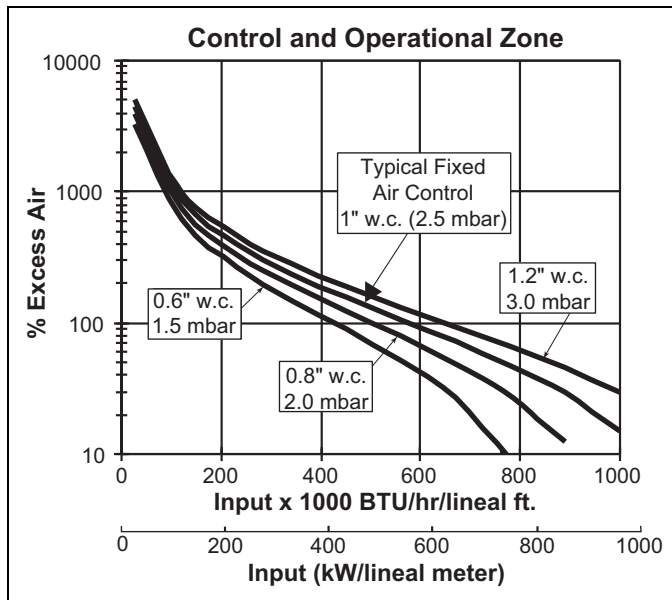

1. Determine Air Factor (1+ excess air %) = 1.44
2. Determine Fuel Flow (Input/Gross Heating Value\*) = (1,600,000/1000) = 1,600 scfh
3. Determine Air Flow (Air Factor x Stoichiometric Air Requirement\* x Fuel Flow) = 1.44 x 10 x 1,600 = 23,040 scfh air flow

\* See Fuel Type Table

## Step 3: Control Methodology

Input is normally controlled by a motorized butterfly valve in the gas line to the burner.

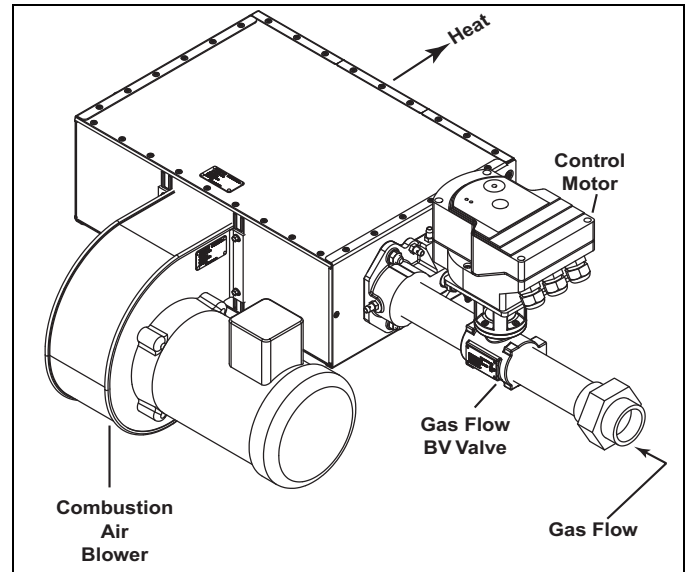

- A control signal is sent from a process temperature controller (sold separately) to the control motor. (Refer to Bulletin 818C or contact Eclipse Combustion for further information on temperature controllers.)

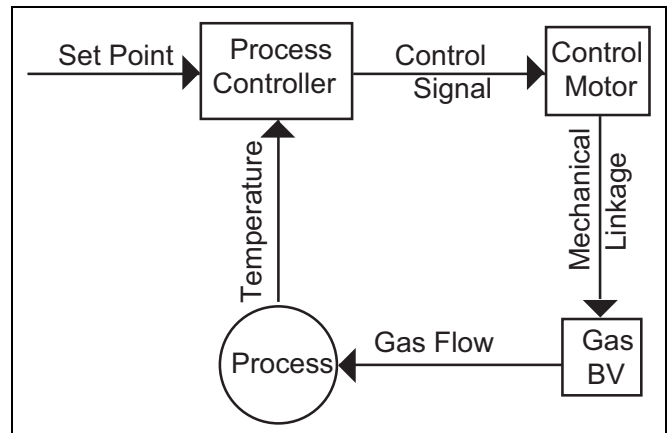

- The control motor modulates the gas butterfly valve (BV) which controls the fuel flow to the burner.
- Air pressure and flow in the burner body remain fixed throughout the operating range.
- Modulation of fuel flow only, provides turndowns of 40:1.



- Do not use other control methods without prior approval from Eclipse.



## **Step 4: Ignition System**

### **Ignition Transformer**

For the ignition system, use a transformer with:

- secondary voltage 6000 to 8000 VAC
- minimum secondary current 0.02 amp continuous
- full wave output

**DO NOT USE** the following:

- twin outlet transformer
- distributor type transformer

### **Trial For Ignition**

It is recommended that low fire start be used. However, under certain circumstances AirHeat burners are capable of direct spark ignition at higher gas inputs.

Most local safety codes and insurance requirements limit the maximum trial for ignition time (the time it takes for a burner to ignite). These requirements vary from one location to another; check your local codes and comply to the strictest codes applicable.

The time it takes for a burner to ignite depends on the following:

- the distance between the gas shut-off valve and the burner.
- the gas flow conditions at start-up.

The possibility exists where the low fire is too low to ignite the burner within the maximum trial for ignition time. The following options must be considered under these conditions:

- start at higher gas input levels.
- resize and/or relocate the gas controls.
- use spark ignited pilot.

### **Ignition Gas Piping**

AirHeat burners are capable of ignition with either direct spark or spark ignited pilot.

#### **Direct Spark Ignition**

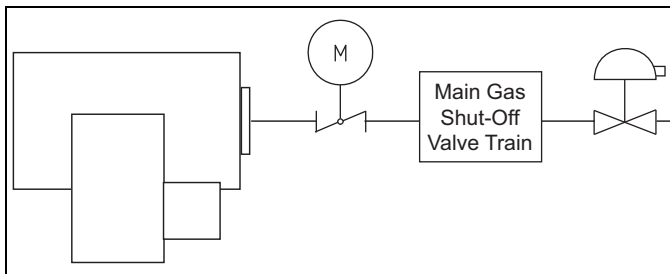

#### **Spark Ignited Pilot**

When ordered, the pilot is packaged with the burner and includes an adjustable flow gas cock and pressure regulator.

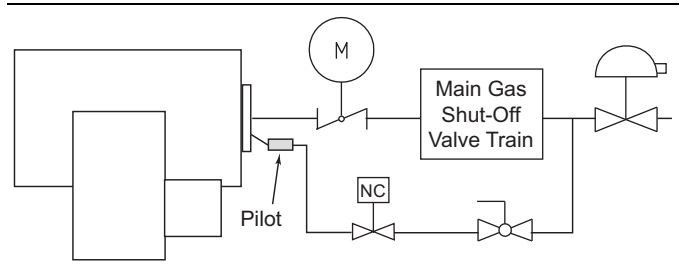

- It is not possible to use a continuous or intermittent pilot. The pilot fuel flow should be interrupted after the trial ignition period has expired.

## **Step 5: Flame Monitoring Control System**

The flame monitoring control system consists of two main components:

- flame sensor
- flame monitoring control

### **Flame Sensor**

Two types can be used on AirHeat Burners:

- flame rod
- UV scanner

The UV scanner must be compatible to the flame monitoring control that is used. Refer to the manual of your selected control for proper selection of the scanner.

## Flame Monitoring Control

The flame monitoring control processes the signal from the flame sensor and controls the start-up and shut-down sequences.

Eclipse recommends the following flame monitoring controls:

- Trilogy series T400 (Instruction Manual 830)
- Veri-Flame series 5600 (Instruction Manual 818)
- Bi-Flame series 6500 (Instruction Manual 826)
- Multi-Flame series 6000 (Instruction Manual 820)

If other controls are considered, contact Eclipse to determine how burner performance may be affected. Flame monitoring controls that have lower sensitivity flame detecting circuits may limit burner turndown and change the requirements for ignition.

Flame monitoring controls that stop the spark as soon as a signal is detected may prevent establishment of flame, particularly when using UV scanners. The flame monitoring control must maintain the spark for a fixed time interval that is long enough for ignition.

## **Step 6: Main Gas Shut-Off Valve Train**

### **Component Selection**

Eclipse can help in the design of a main gas shutoff valve train that satisfies the customer and complies with all local safety standards and codes set by the authorities within that jurisdiction. Contact Eclipse for further information.

**NOTE:** Eclipse supports NFPA regulations (two gas shut-off valves as a minimum standard for main gas shut-off systems).

### **Valve Train Size**

Fuel pressure supplied to the burner inlet (Tap B) must be 10" w.c. The valve train should be sized sufficiently to provide the specified pressure.

# Appendix

## Conversion Factors

### Metric to English

From	To	Multiply By
actual cubic meter/h (am <sup>3</sup> /h)	actual cubic foot/h (acfh)	35.31
normal cubic meter/h (Nm <sup>3</sup> /h)	standard cubic foot /h (scfh)	38.04
degrees Celsius (°C)	degrees Fahrenheit (°F)	(°C x 9/5) + 32
kilogram (kg)	pound (lb)	2.205
kilowatt (kW)	Btu/h	3415
meter (m)	foot (ft)	3.281
millibar (mbar)	inches water column ("w.c.)	0.402
millibar (mbar)	pounds/sq in (psi)	14.5 x 10 <sup>-3</sup>
millimeter (mm)	inch (in)	3.94 x 10 <sup>-2</sup>
MJ/Nm <sup>3</sup>	Btu/ft <sup>3</sup> (standard)	26.86







### Metric to Metric



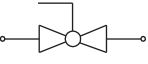
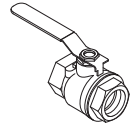
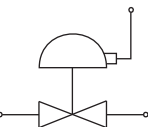
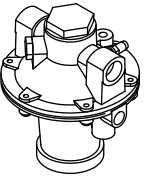

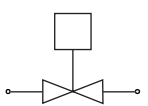
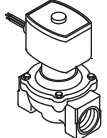

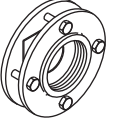

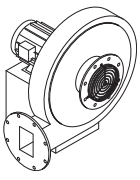

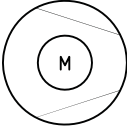
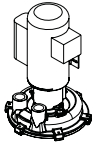
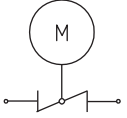
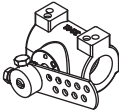
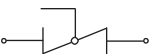
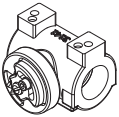
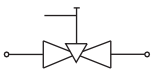

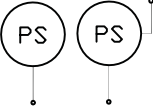
From	To	Multiply By
kiloPascals (kPa)	millibar (mbar)	10
meter (m)	millimeter (mm)	1000
millibar (mbar)	kiloPascals (kPa)	0.1
millimeter (mm)	meter (m)	0.001

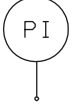
### English to Metric

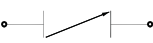
From	To	Multiply By
actual cubic foot/h (acfh)	actual cubic meter/h (am <sup>3</sup> /h)	2.832 x 10 <sup>-2</sup>
standard cubic foot /h (scfh)	normal cubic meter/h (Nm <sup>3</sup> /h)	2.629 x 10 <sup>-2</sup>
degrees Fahrenheit (°F)	degrees Celsius (°C)	(°F - 32) x 5/9
pound (lb)	kilogram (kg)	0.454
Btu/h	kilowatt (kW)	0.293 x 10 <sup>-3</sup>
foot (ft)	meter (m)	0.3048
inches water column ("w.c.)	millibar (mbar)	2.489
pounds/sq in (psi)	millibar (mbar)	68.95
inch (in)	millimeter (mm)	25.4
Btu/ft <sup>3</sup> (standard)	MJ/Nm <sup>3</sup>	37.2 x 10 <sup>-3</sup>

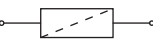
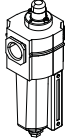
# System Schematics

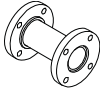
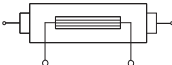
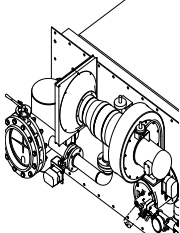
Symbol	Appearance	Name	Remarks	Bulletin/ Info Guide
		Gas Cock	Gas cocks are used to manually shut off the gas supply.	710
		Ratio Regulator	A ratio regulator is used to control the air/gas ratio. The ratio regulator is a sealed unit that adjusts the gas pressure in ratio with the air pressure. To do this, it measures the air pressure with a pressure sensing line, the impulse line. This impulse line is connected between the top of the ratio regulator and the burner body.	
		Main Gas Shut-Off Valve Train	Eclipse strongly endorses NFPA as a minimum.	790/791
		Pilot Gas Valve Train	Eclipse strongly endorses NFPA as a minimum.	790/791
		Automatic Shut-Off Valve	Shut-off valves are used to automatically shut off the gas supply on a gas system or a burner.	760
		Orifice Meter	Orifice meters are used to measure flow.	930
		Combustion Air Blower	The combustion air blower provides the combustion air to the burner(s).	610

Symbol	Appearance	Name	Remarks	Bulletin/ Info Guide
		Hermetic Booster	Booster is used to increase gas pressure.	620
		Automatic Butterfly Valve	Automatic butterfly valves are typically used to set the output of the system.	720
		Manual Butterfly Valve	Manual butterfly valves are used to balance the air or gas flow at each burner.	720
		Adjustable Limiting Orifice	Adjustable limiting orifices are used for fine adjustment of gas flow.	728/730
		Pressure Switch	A switch activated by rise or fall in pressure. A manual reset version requires pushing a button to transfer the contacts when the pressure set point is satisfied.	840
		Pressure Gauge	A device to indicate pressure.	940
		Check Valve	A check valve permits flow only in one direction and is used to prevent back flow of gas.	780
		Strainer	A strainer traps sediment to prevent blockage of sensitive components downstream.	
		Flexible Connector	Flexible connectors isolate components from vibration, mechanical, and thermal stresses.	
		Heat Exchanger	Heat exchangers transfer heat from one medium to another.	500
		Pressure Taps	Pressure taps measure static pressure.	

